



ME MARGARET HOWELL

ME MARGARET HOWELL

An Atelier studio for the clothing designer
Margaret Howell to create bespoke garments
within the east set of railway arches at
Valentia Place, Brixton.



MARGARET HOWELL

Margaret Howell designs clothes for men and women. She began working from home in 1970 and today Margaret Howell Ltd has shops in the UK, Europe and Asia. For her, clothes are part of a considered lifestyle rather than a passing trend, and value materials, craftsmanship and quality.



UTILITARIAN

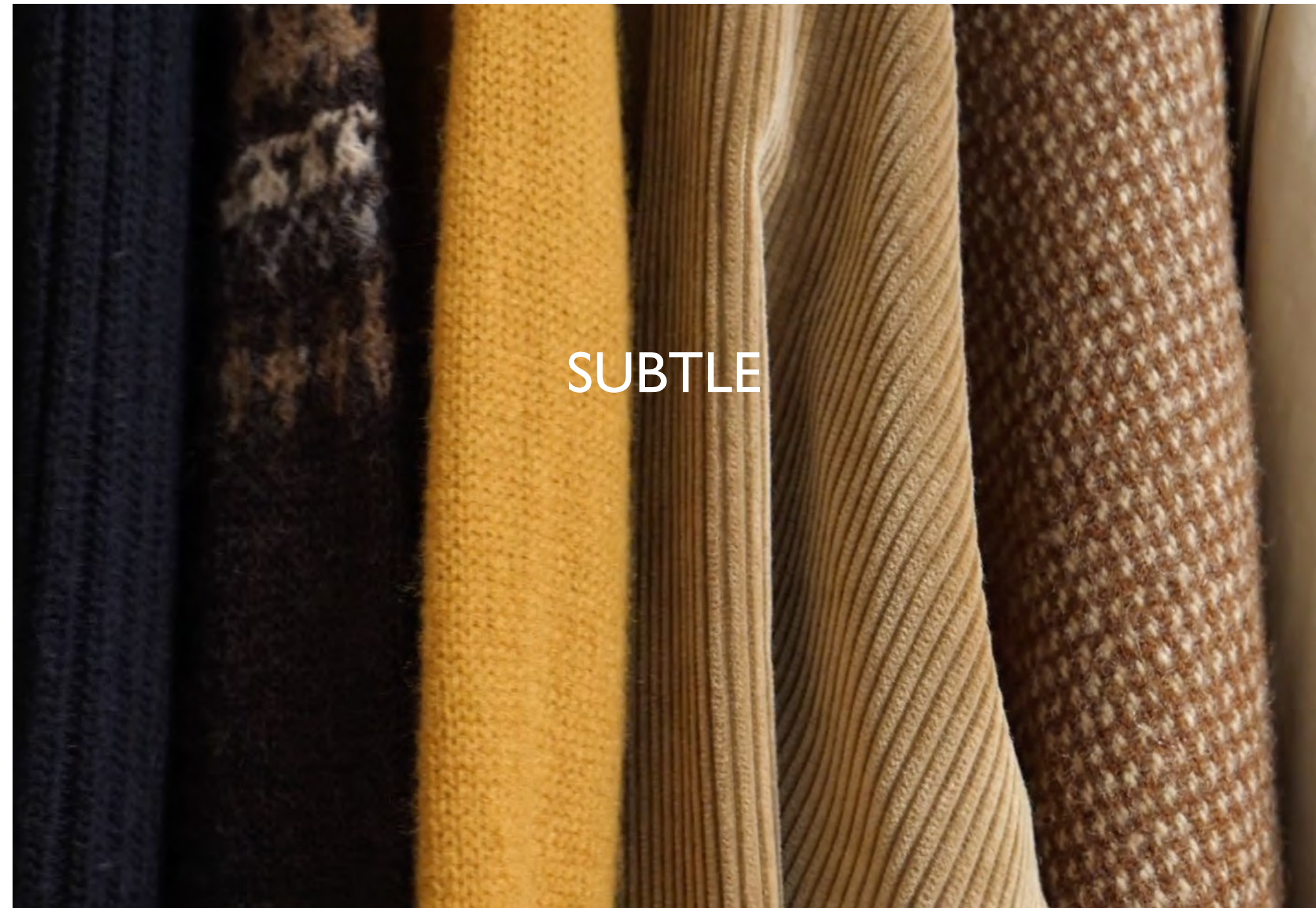

SUBTLE



ELEGANT



QUALITY



TIMELESS



MARGARET
HOWELL



MHL,











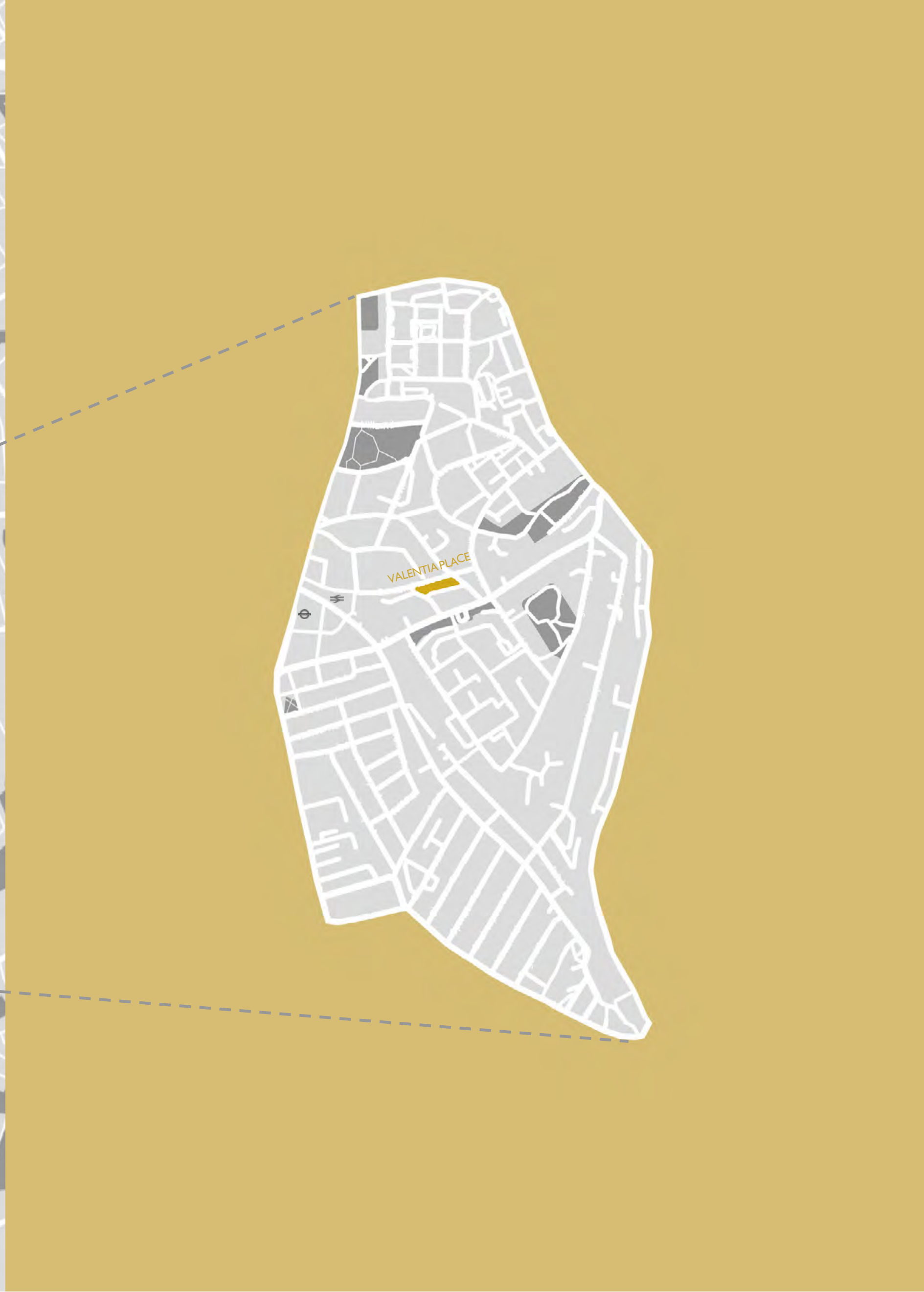



POP
BRIXTON

SITE

GRESHAM ROAD

VALENTA PLACE

BRIXTON
RAILWAY
STATION

BRIXTON
UNDERGROUND
STATION

BRIXTON
VILLAGE
MARKET

ELECTRIC
AVENUE
BRIXTON
MARKET



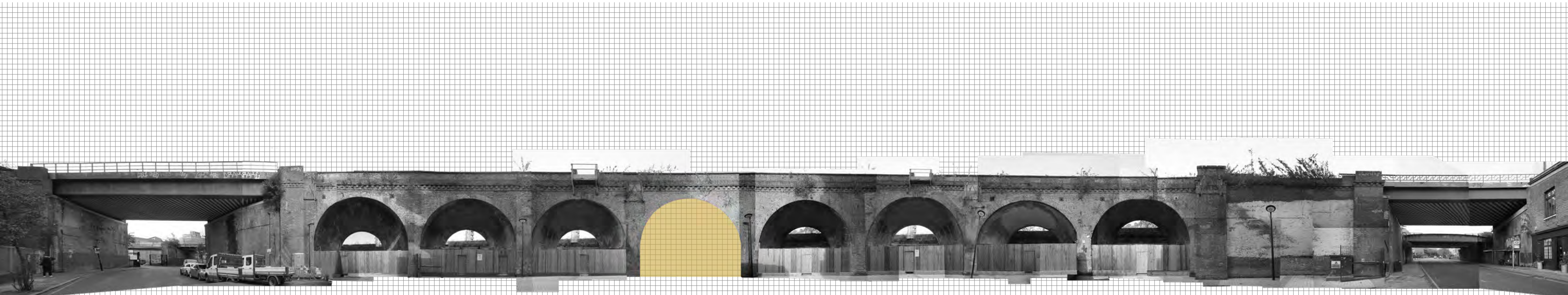

VALENTIA PLACE

GRESHAM ROAD





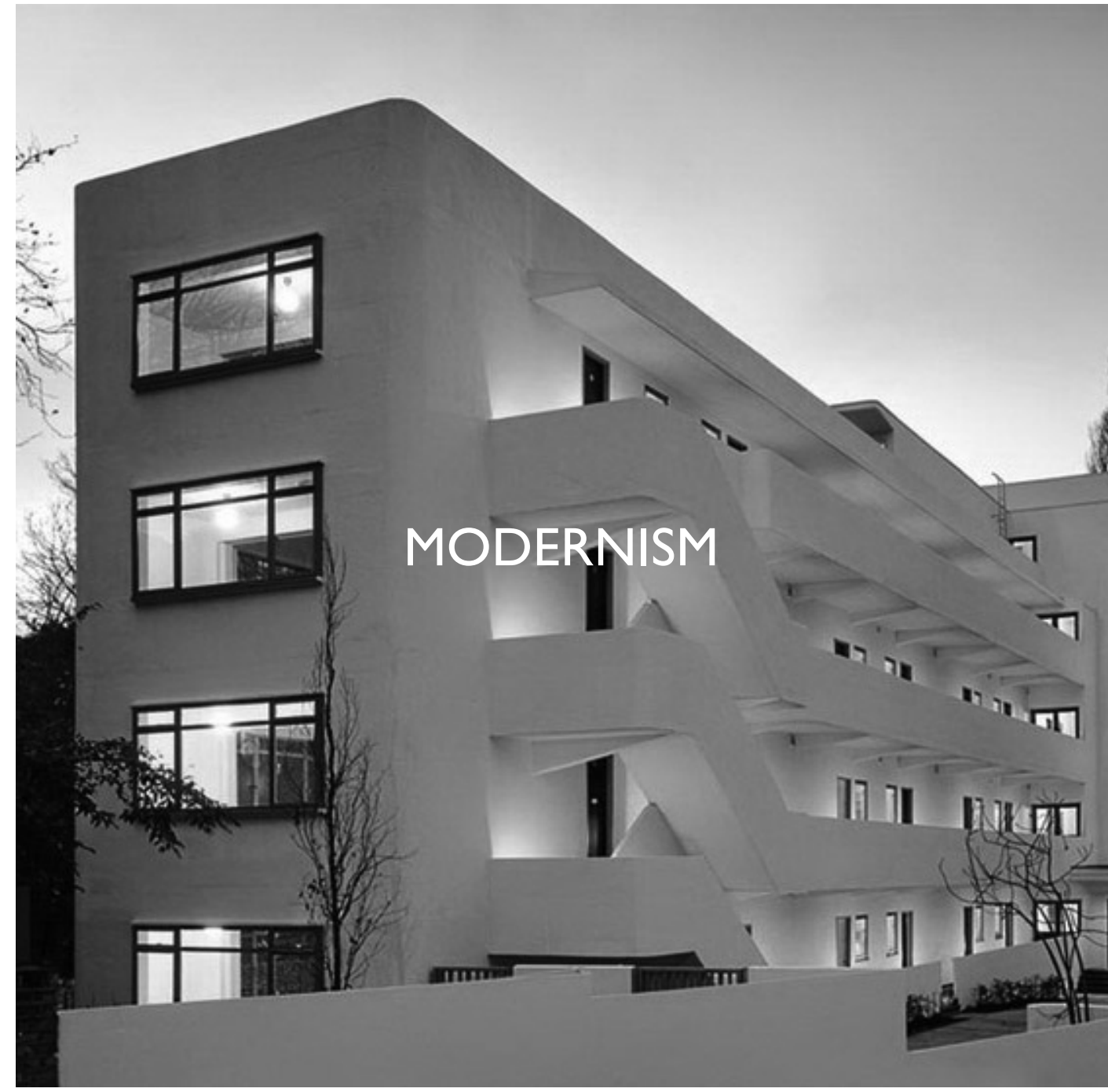





STRATEGY

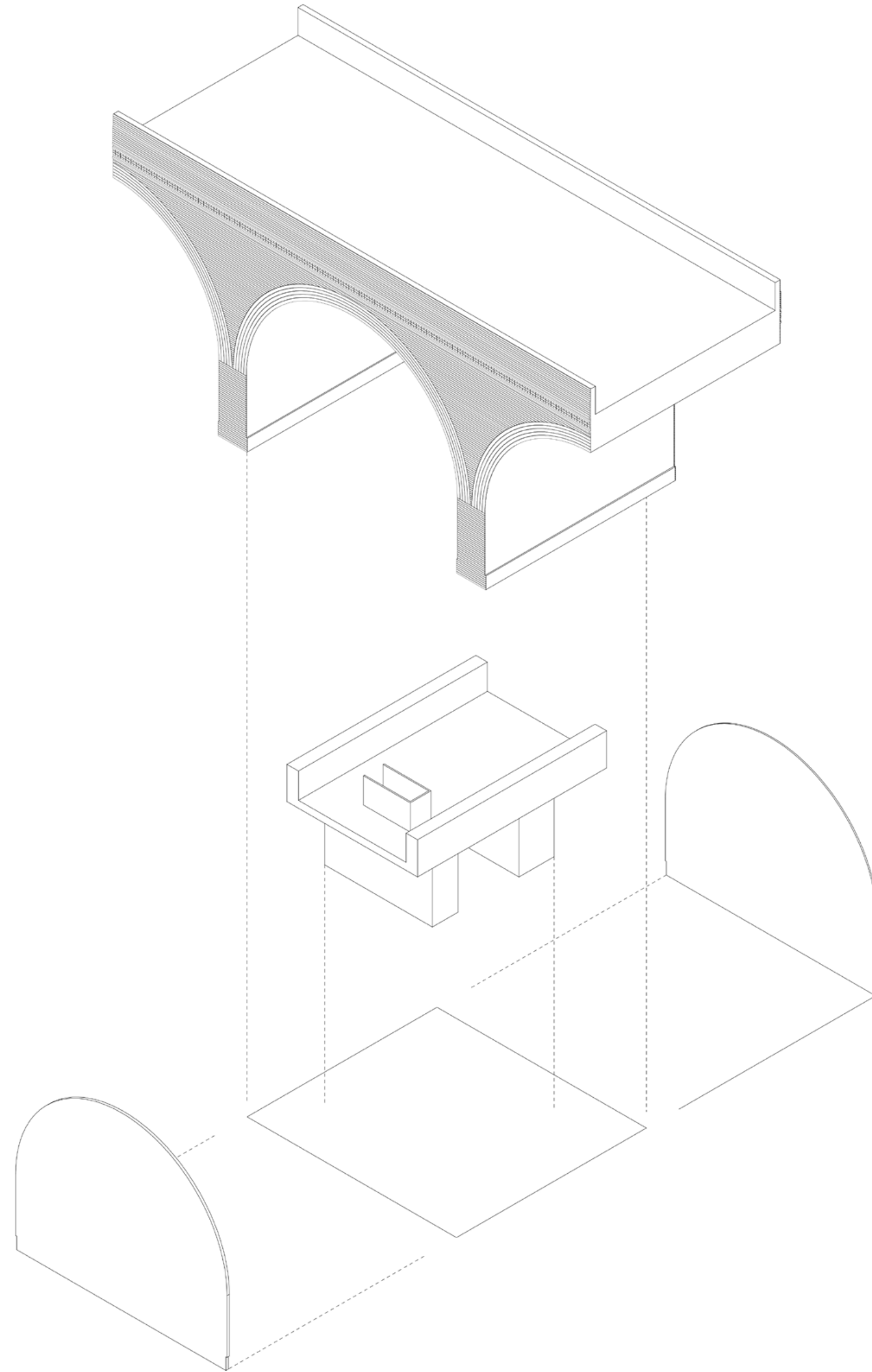

SITE

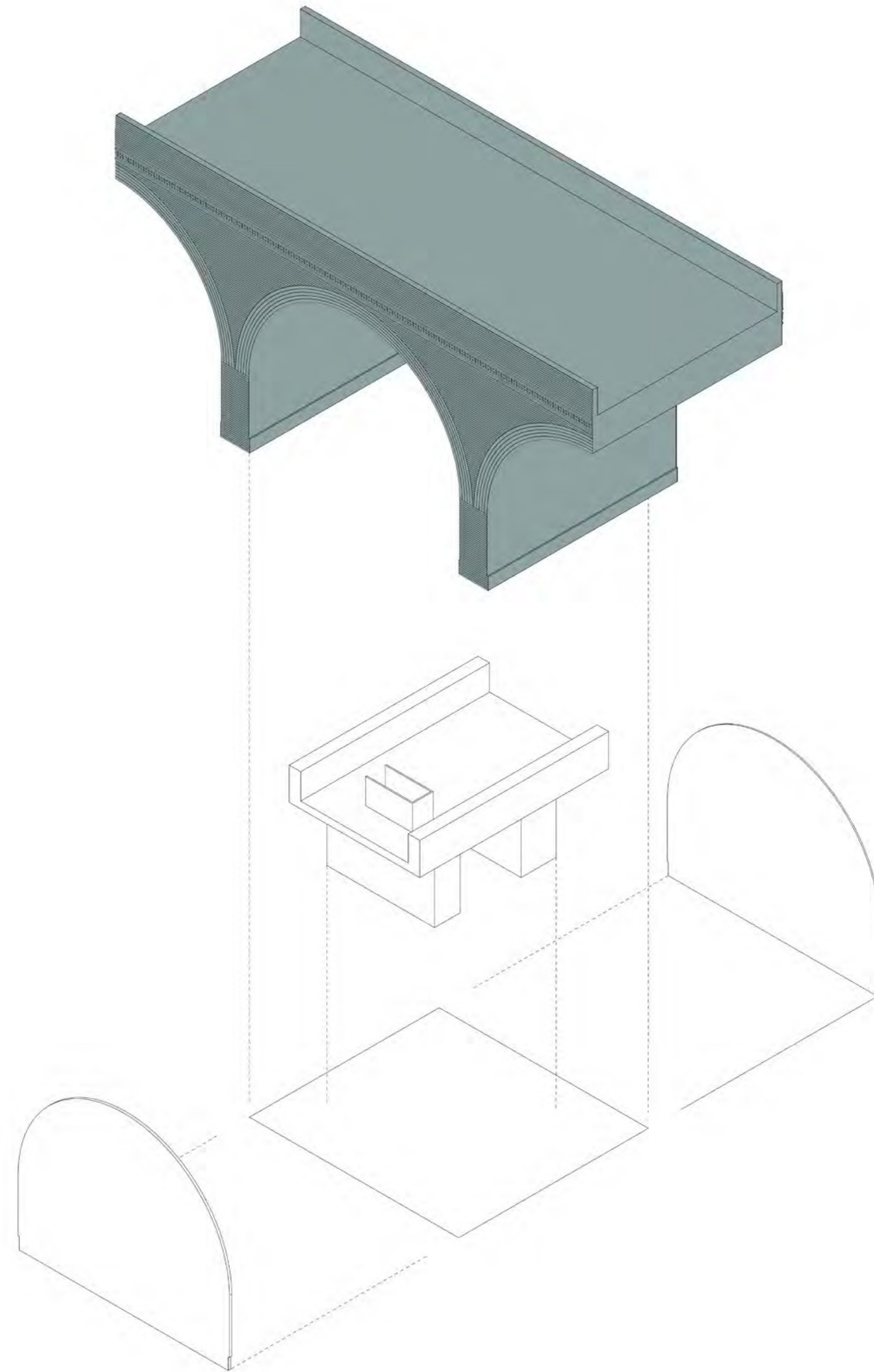

FLOOR

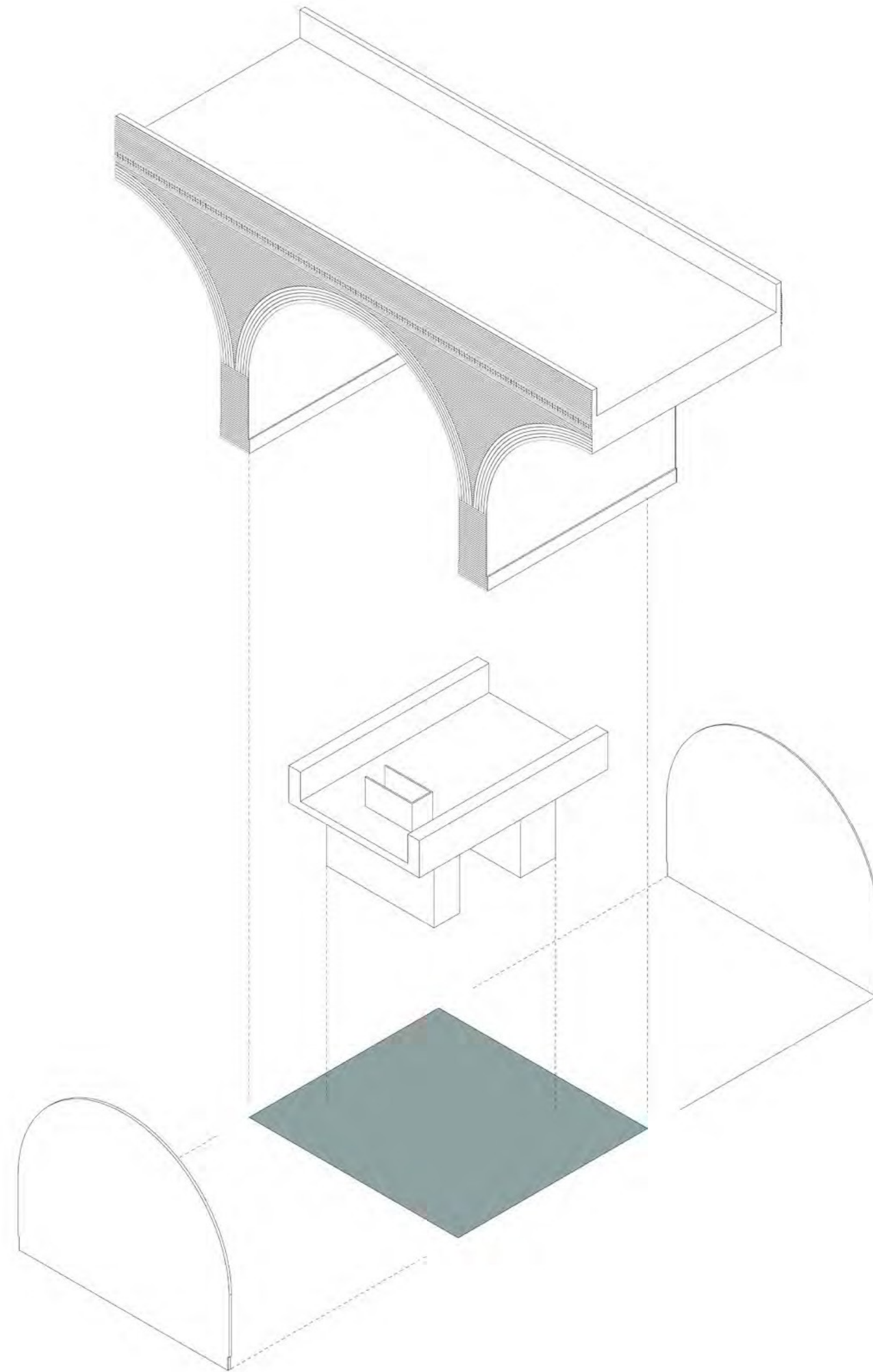

INSTALLATION

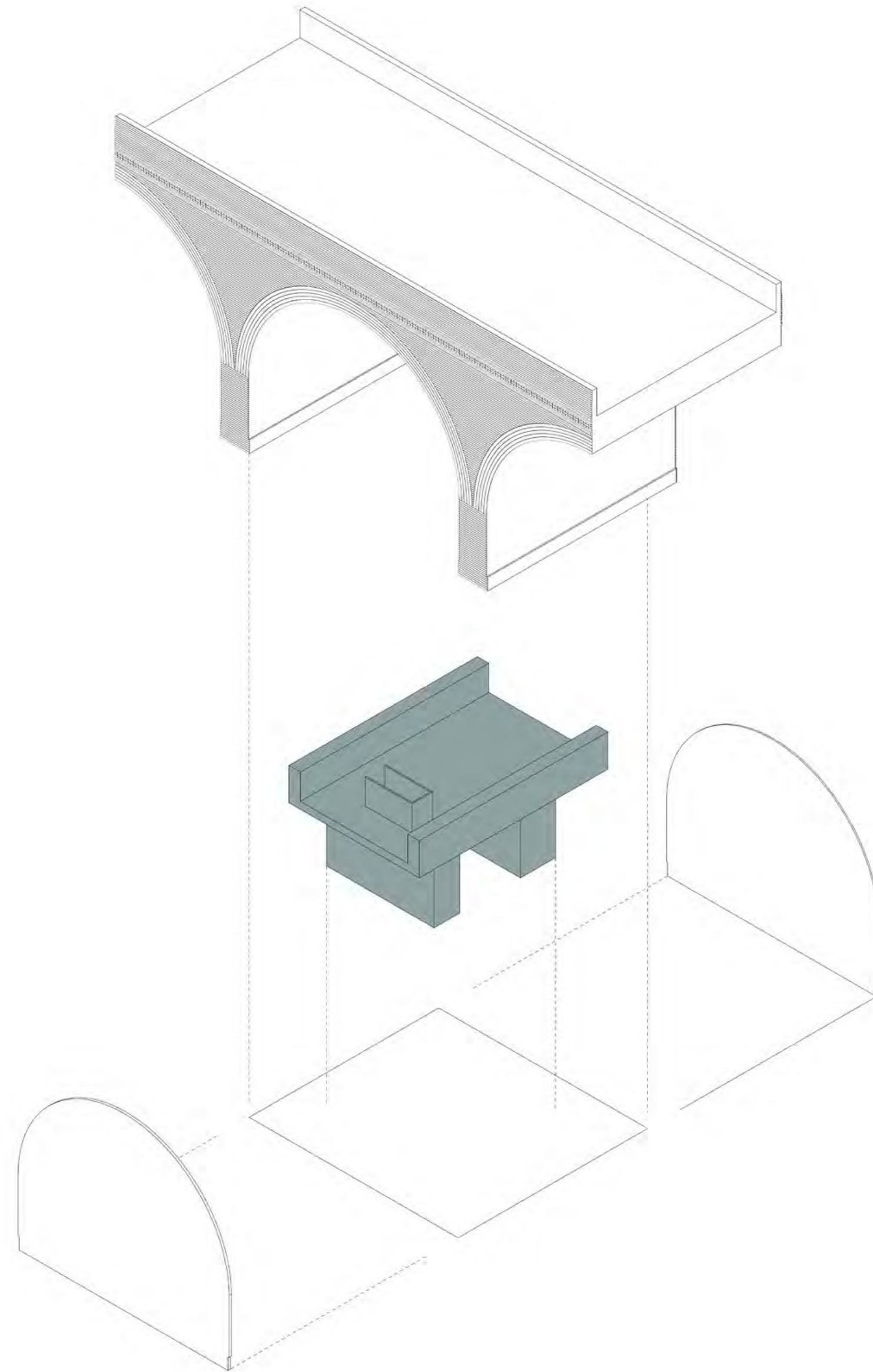

FAÇADES

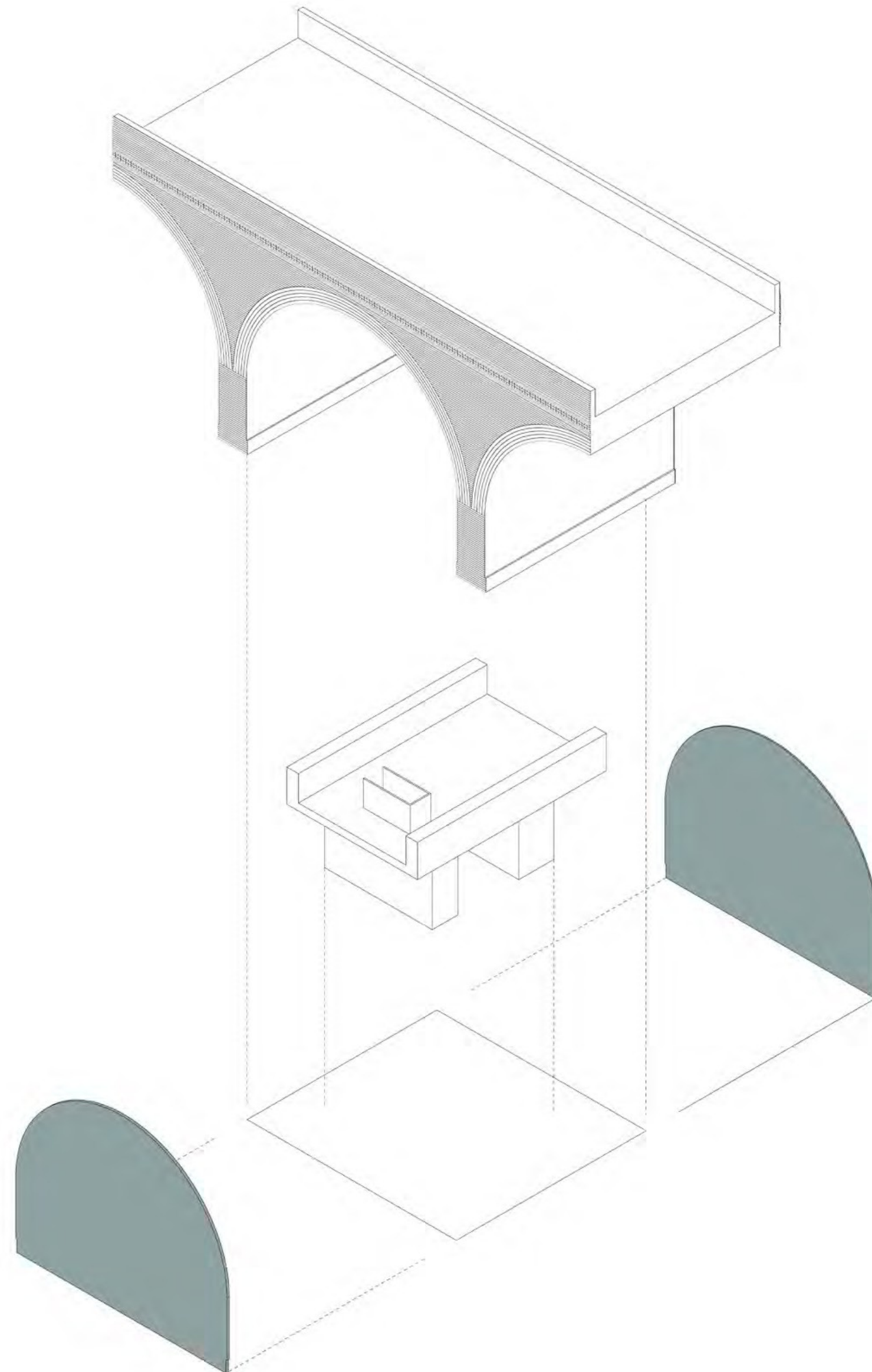



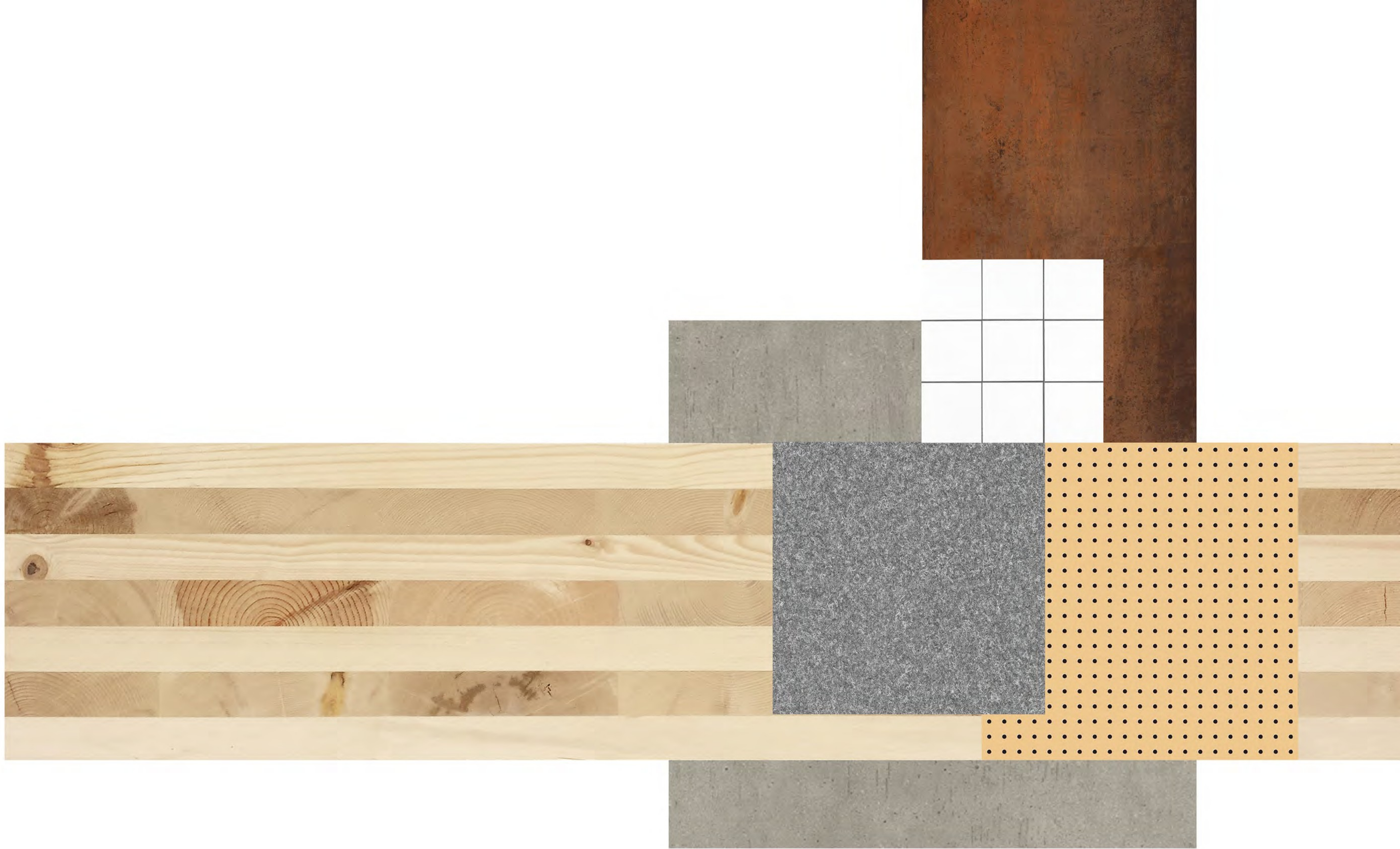

SPATIAL ORGANISATION

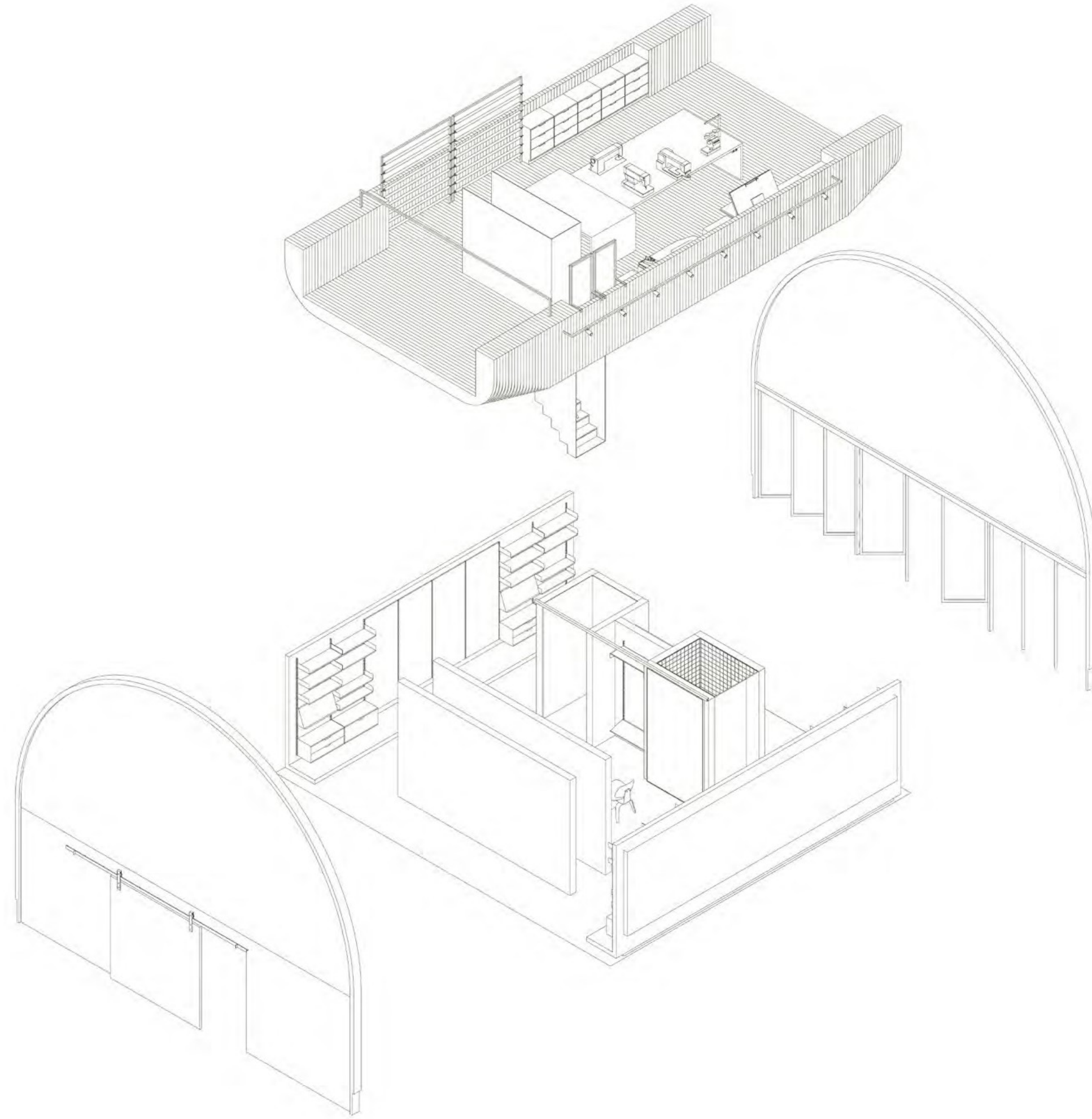

CLIENT

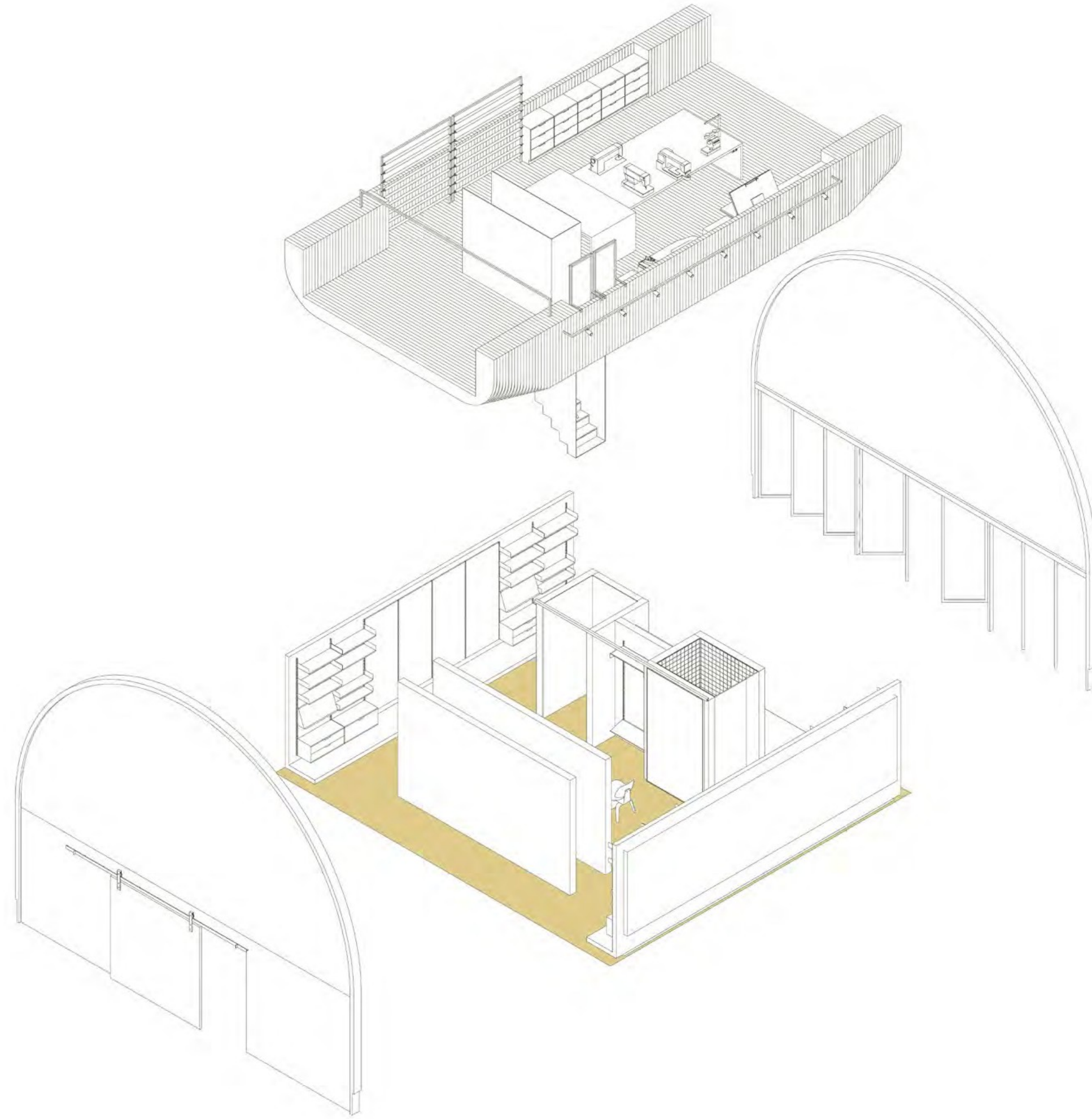

STAFF

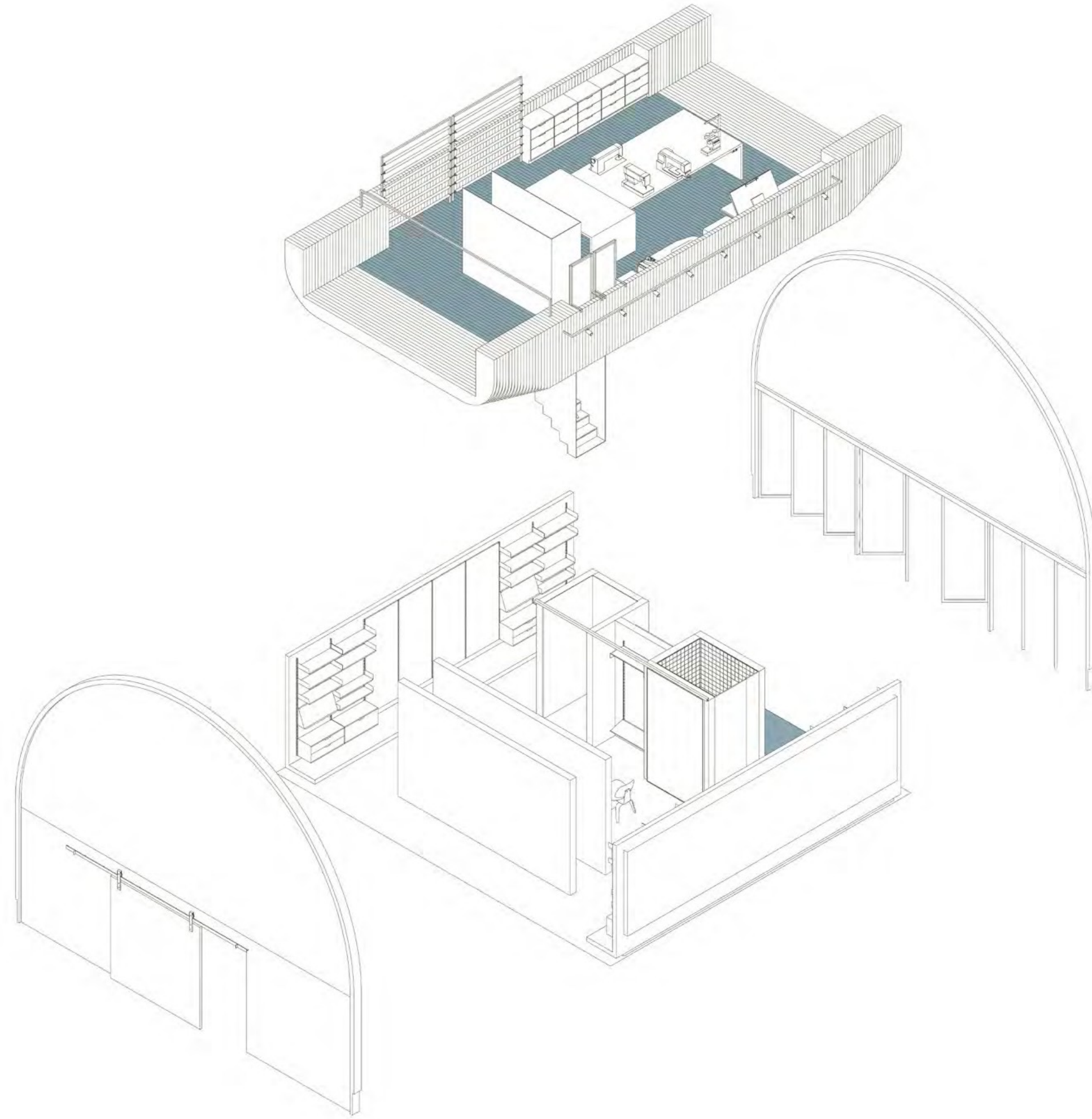

LOBBY

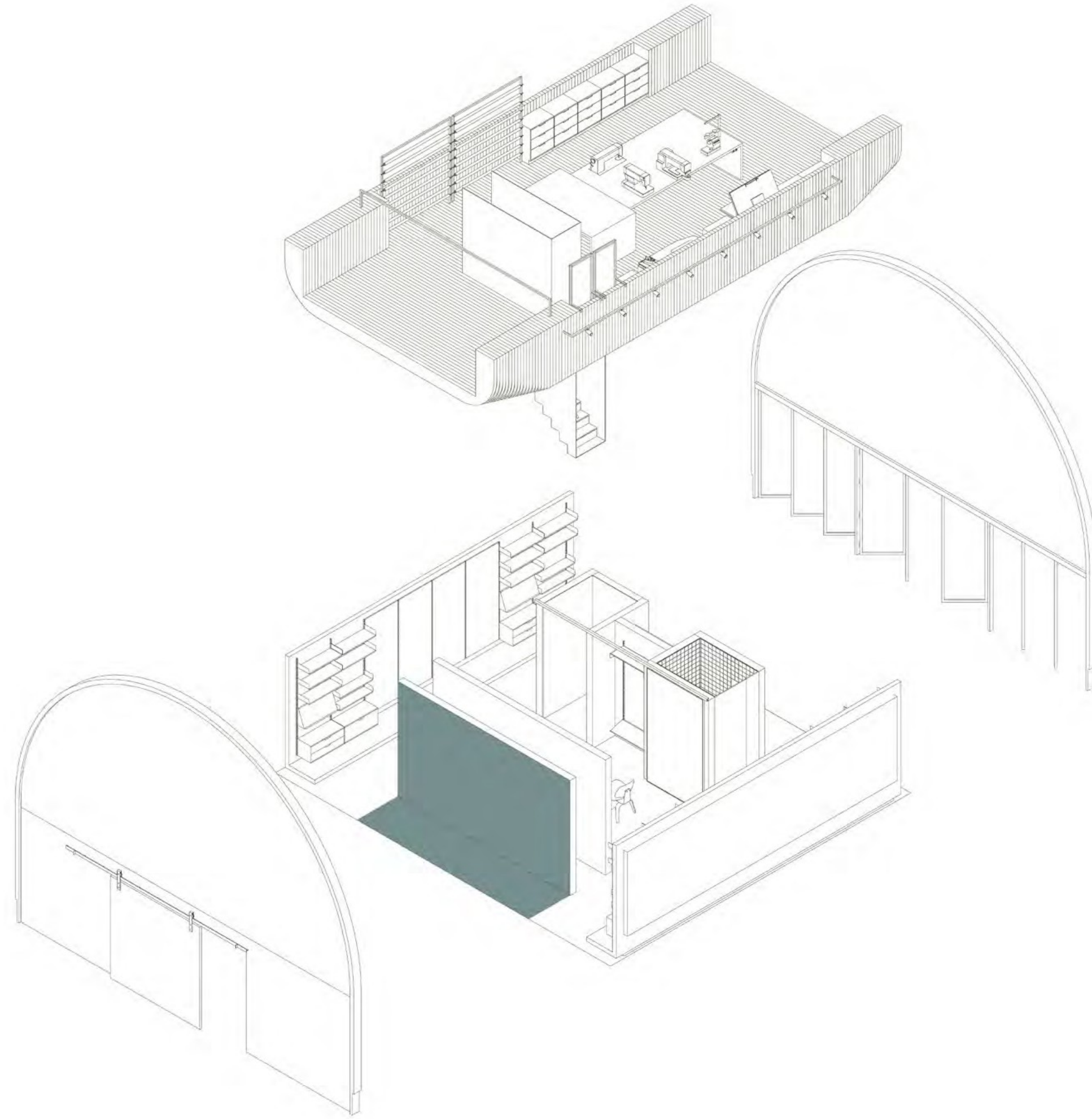

DISPLAY

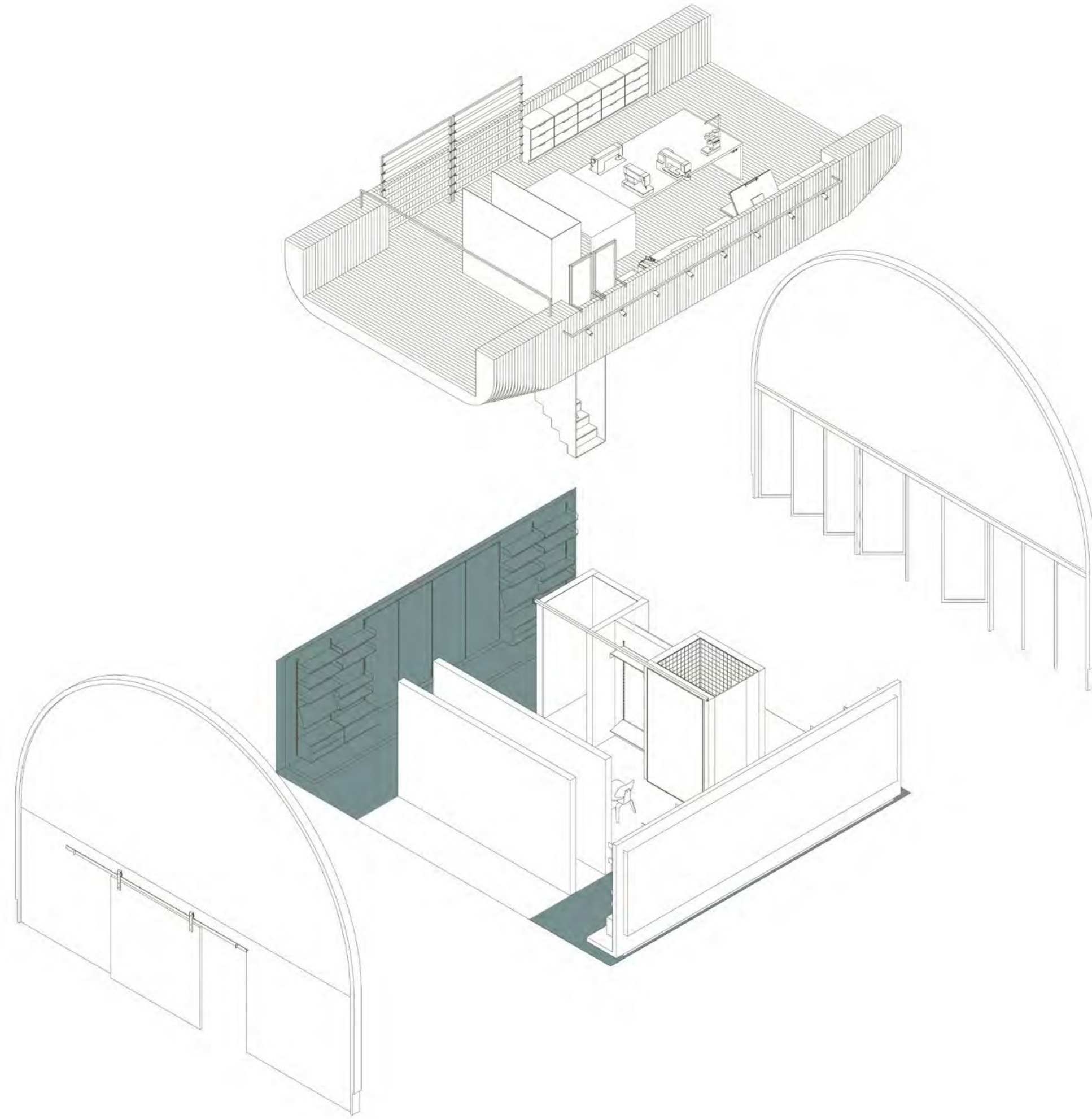

CONSULTATION SPACE

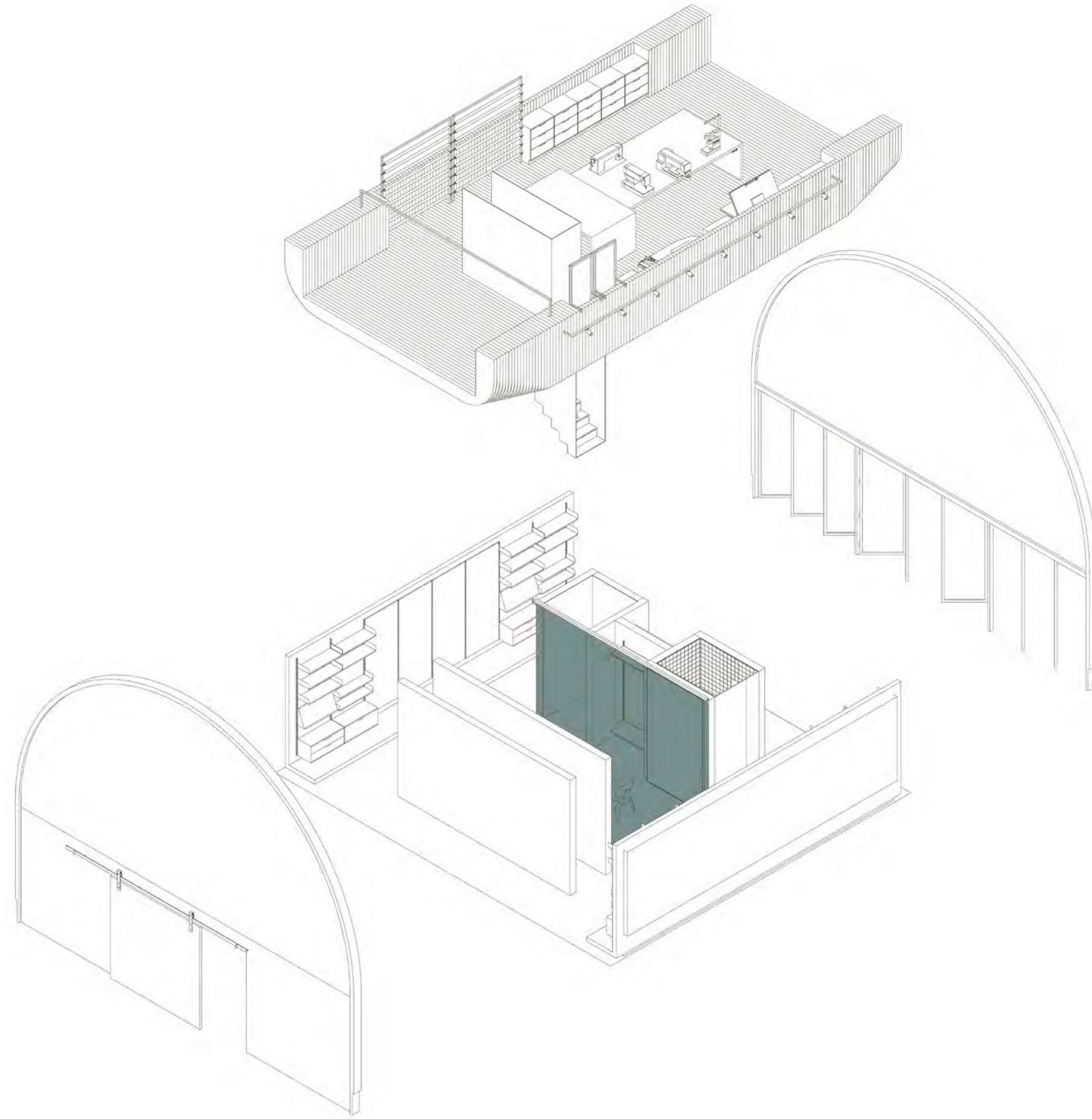

FITTING ROOM

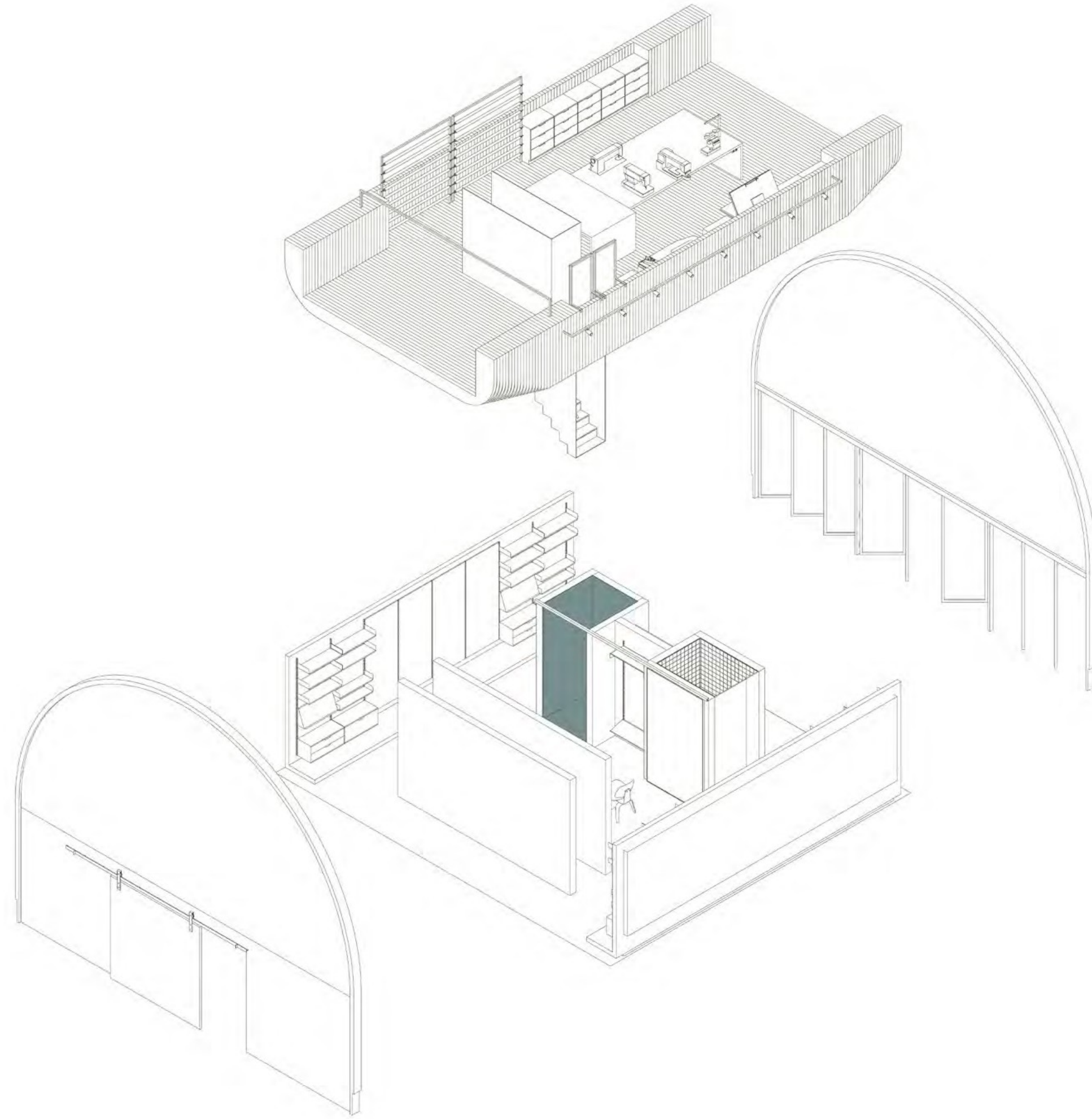

TOILET

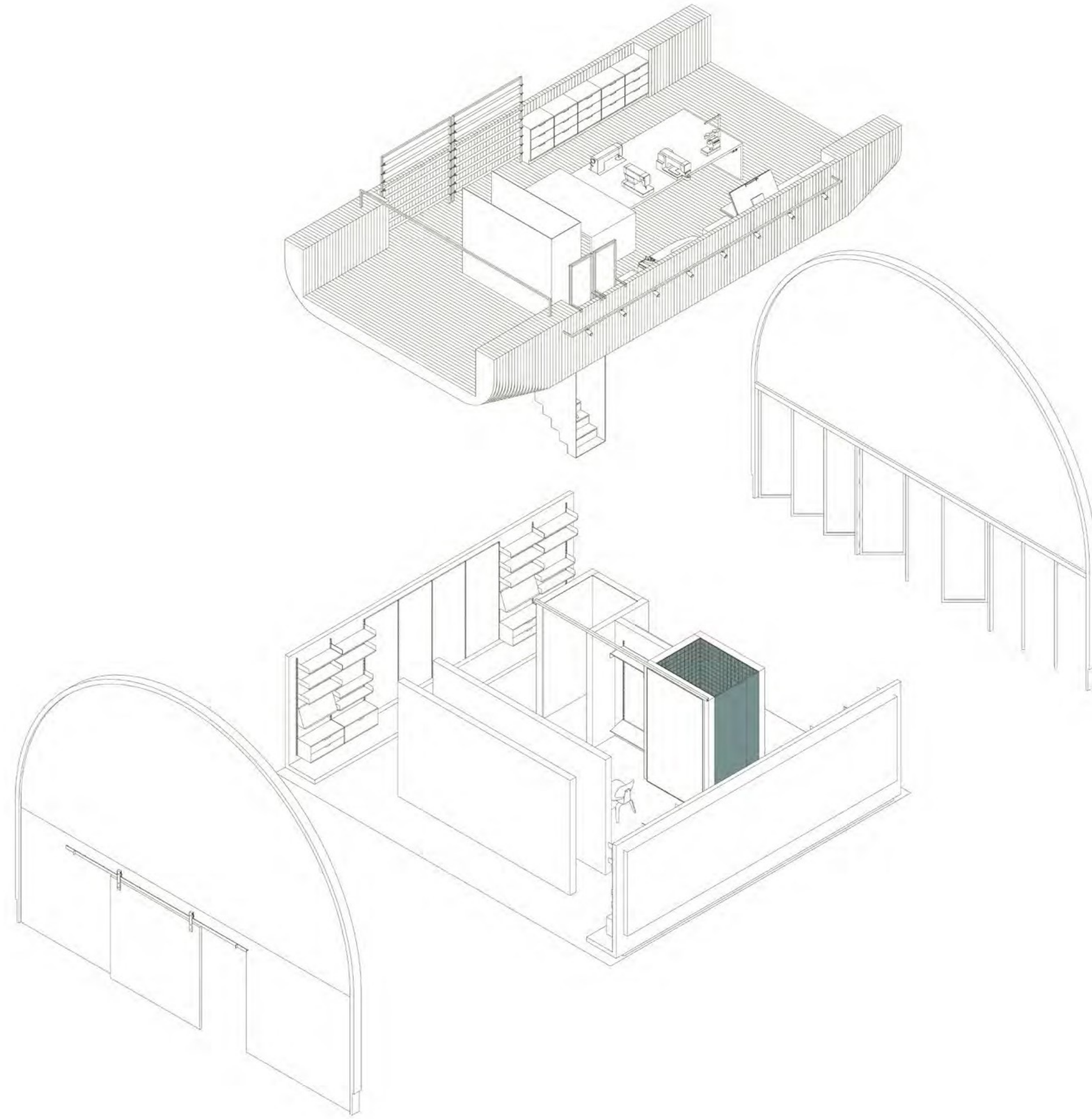

KITCHEN

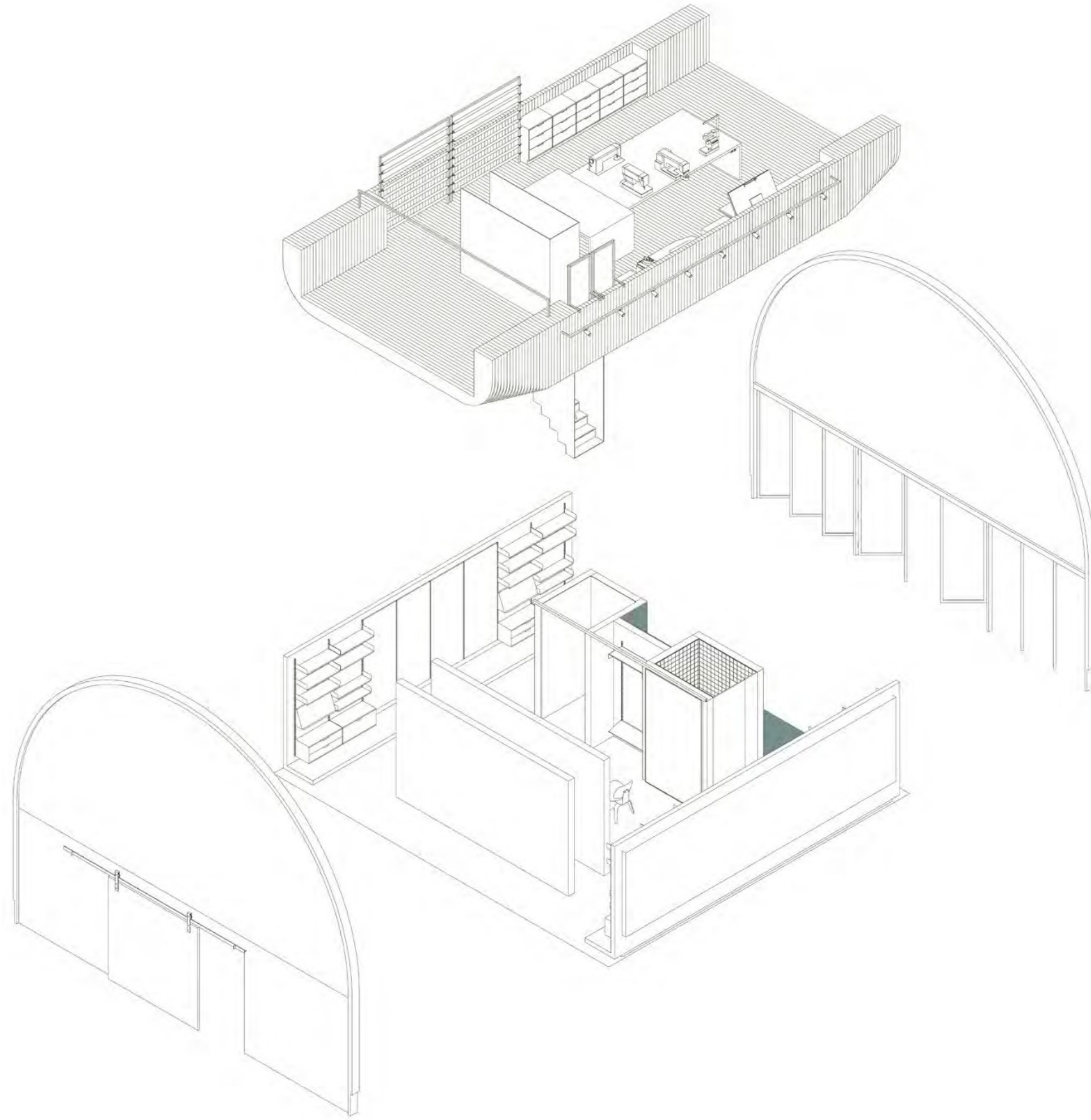

STAIR

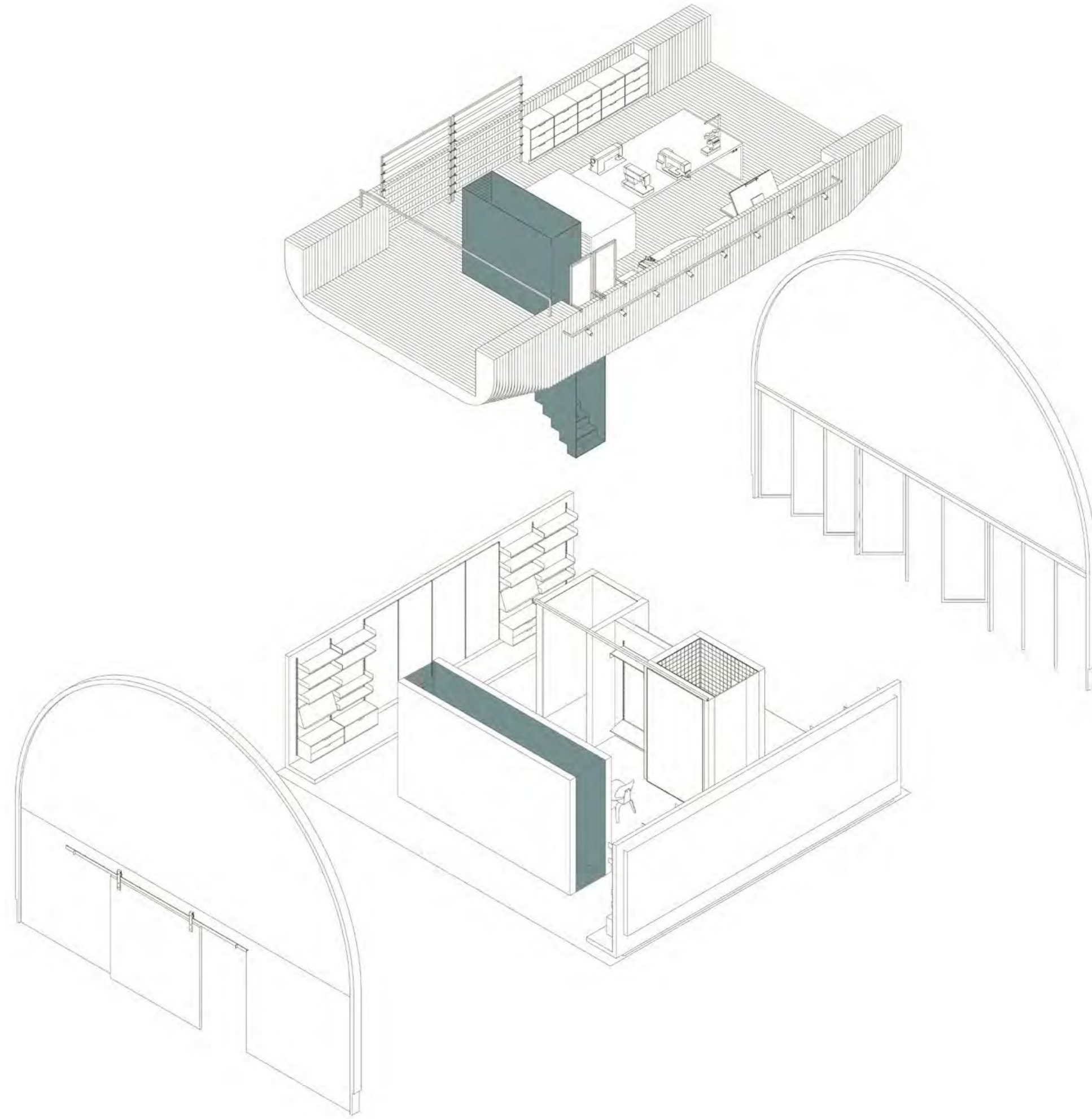

ATELIER

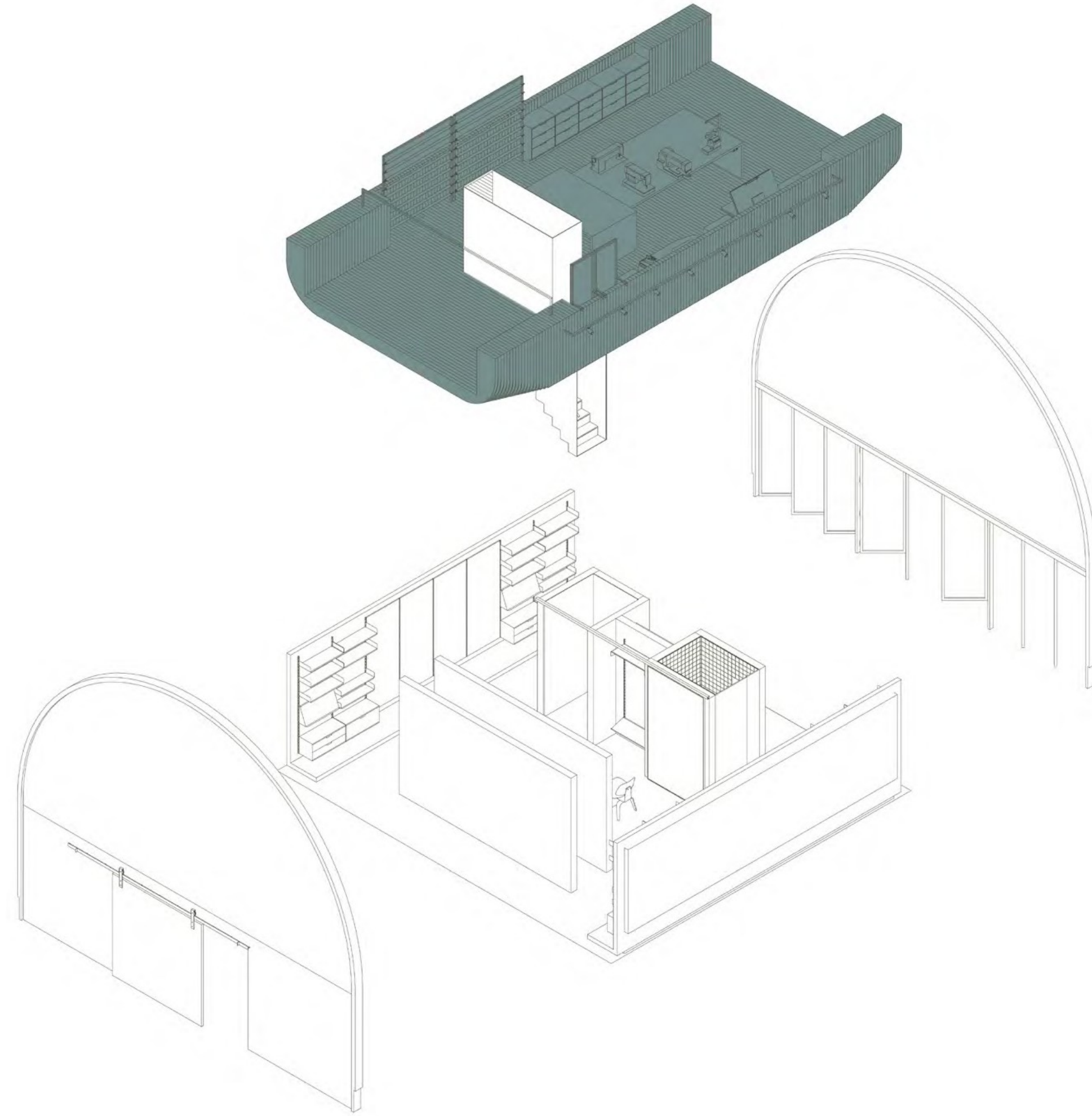

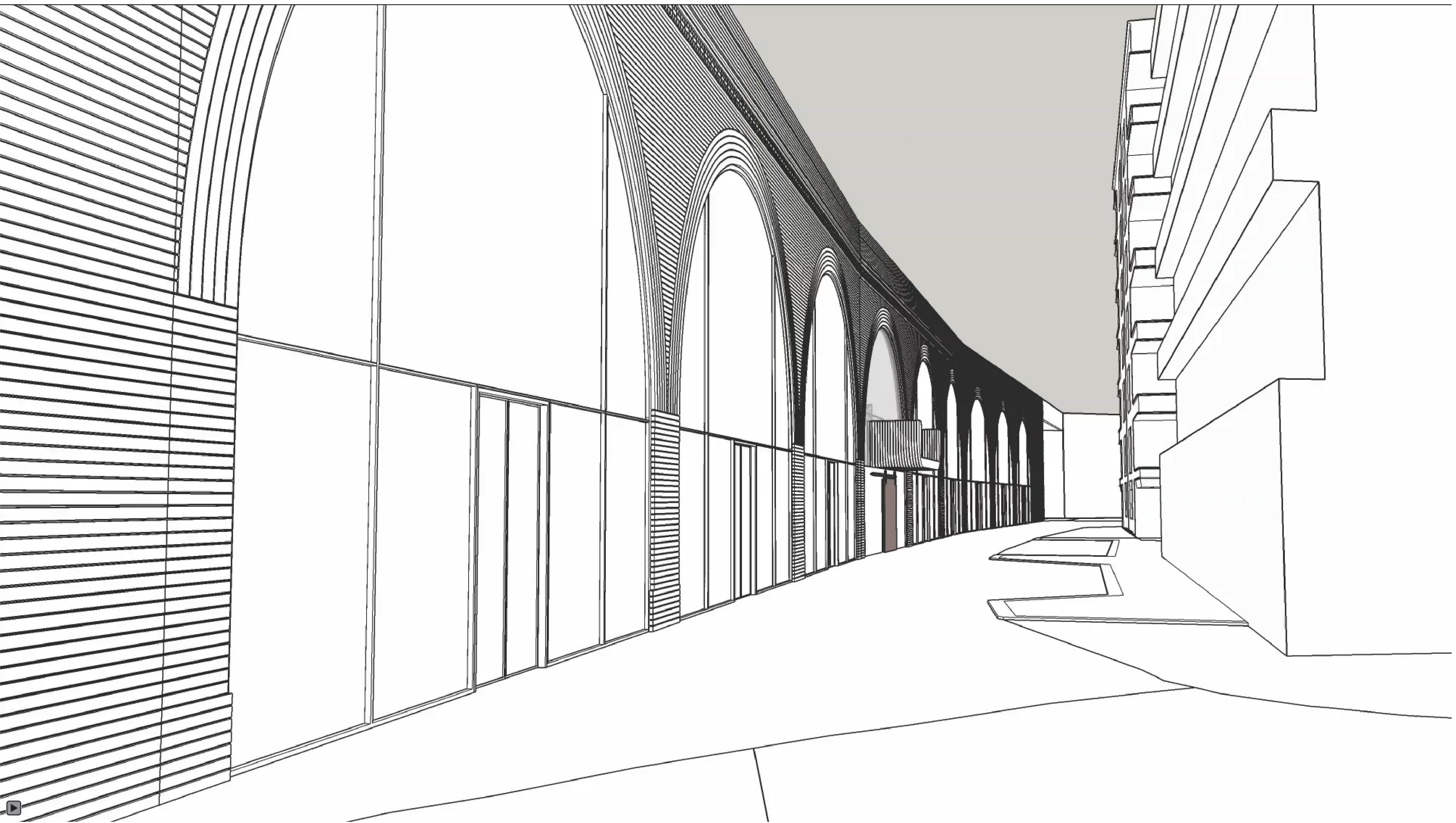



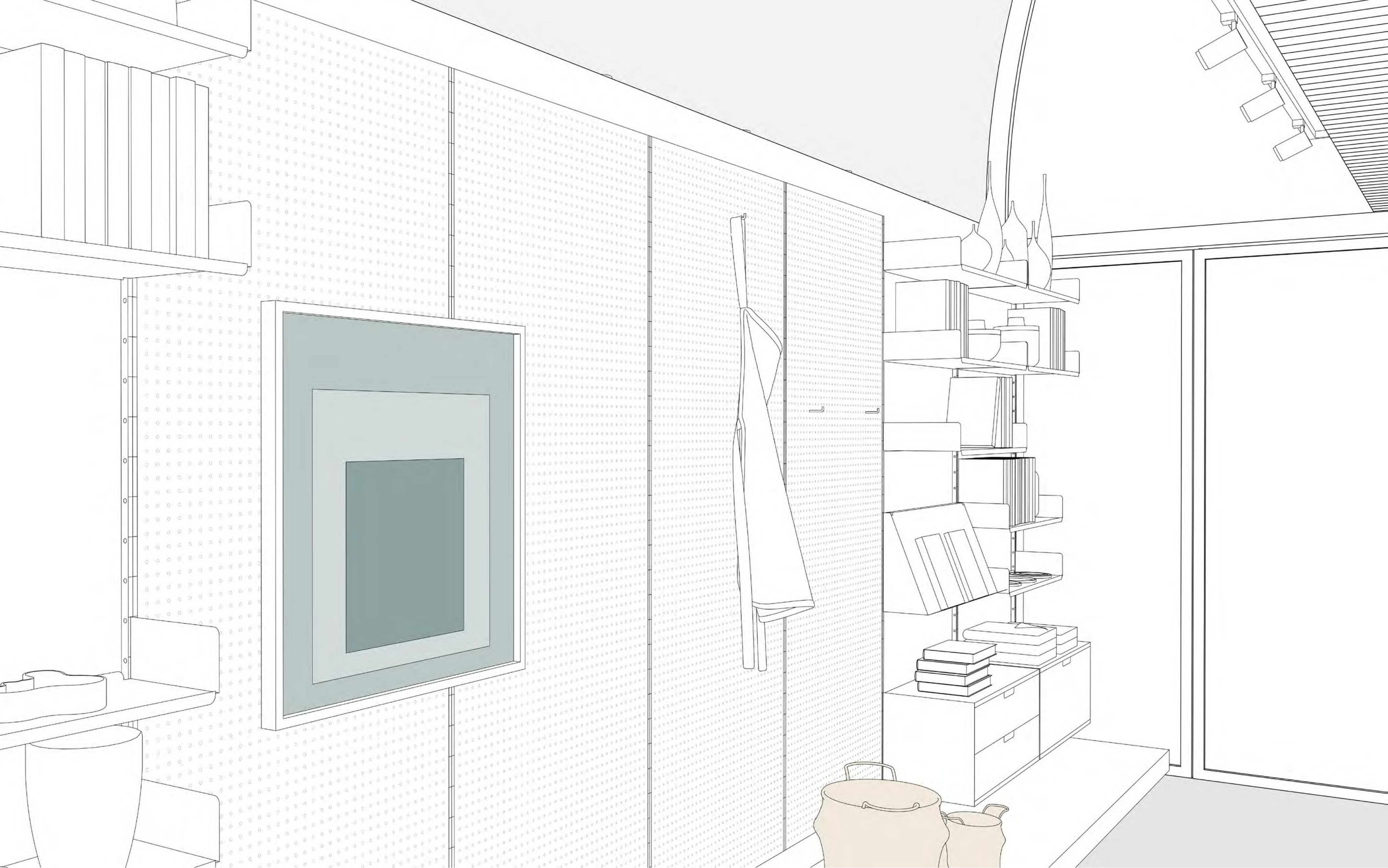





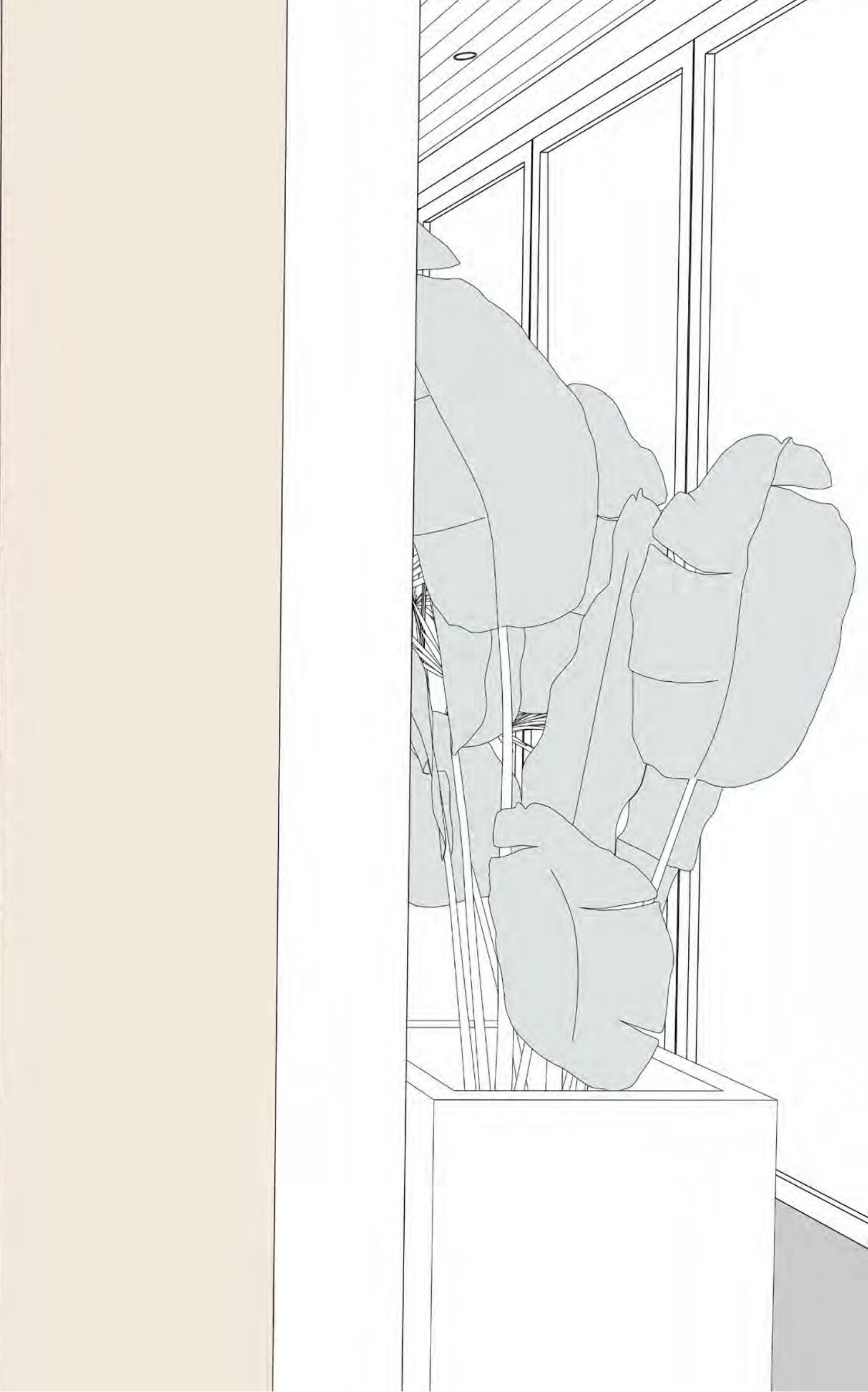
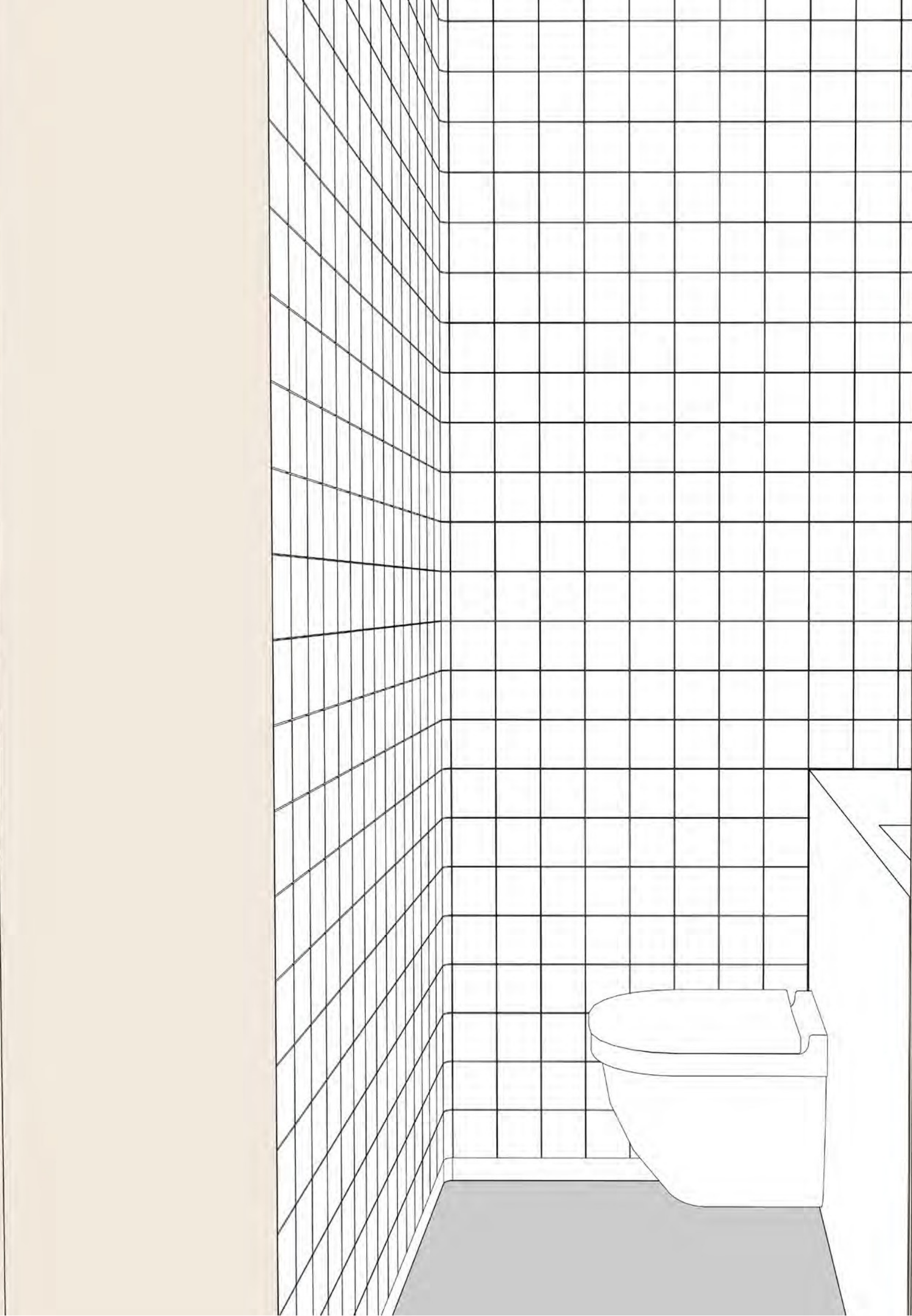
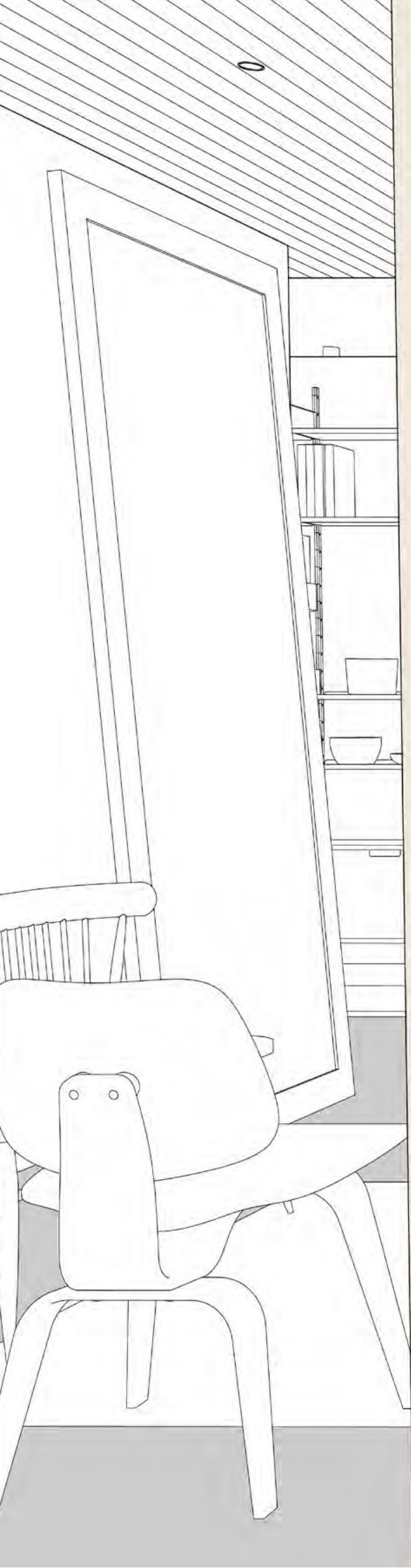





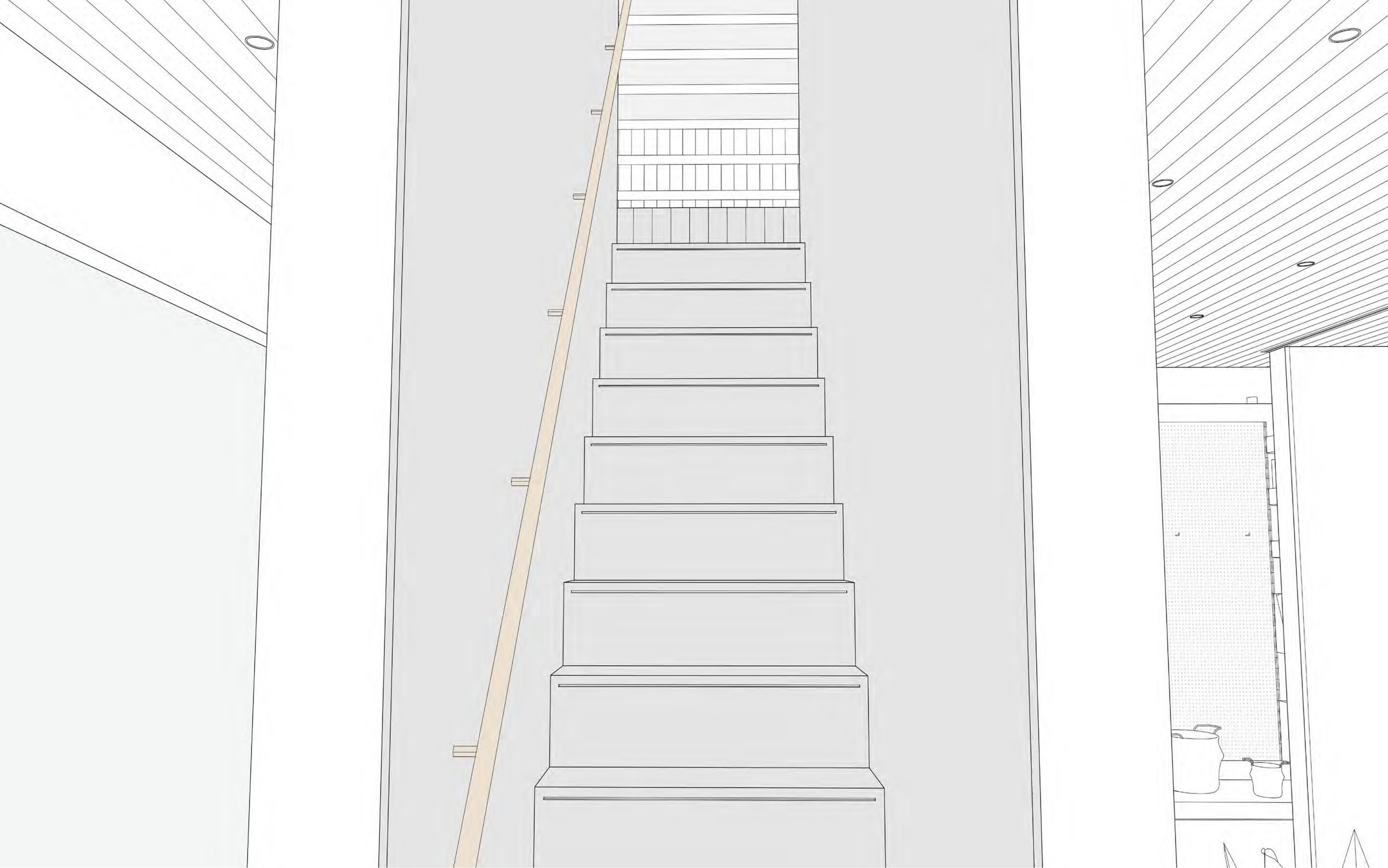



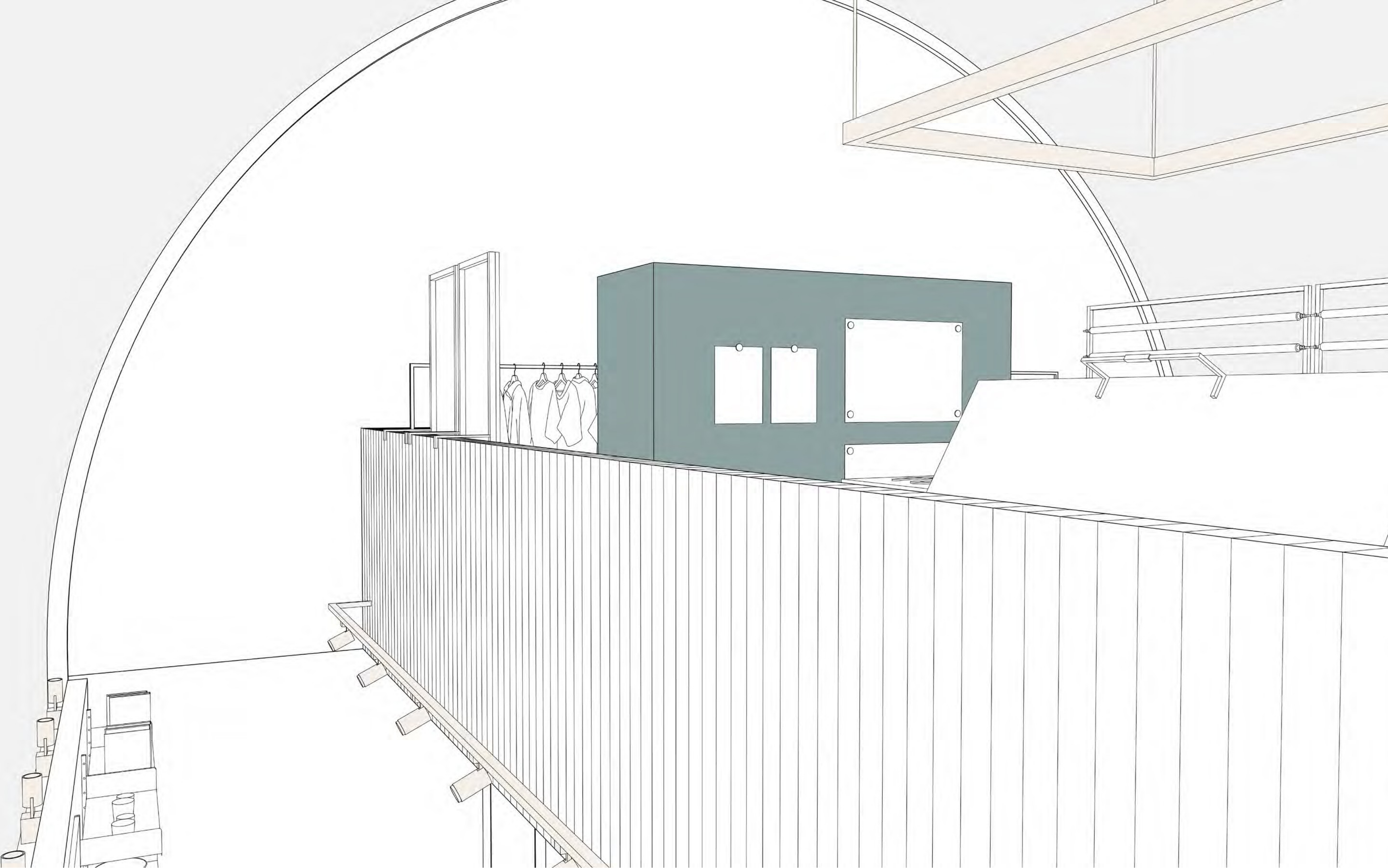

DISPLAY DETAIL

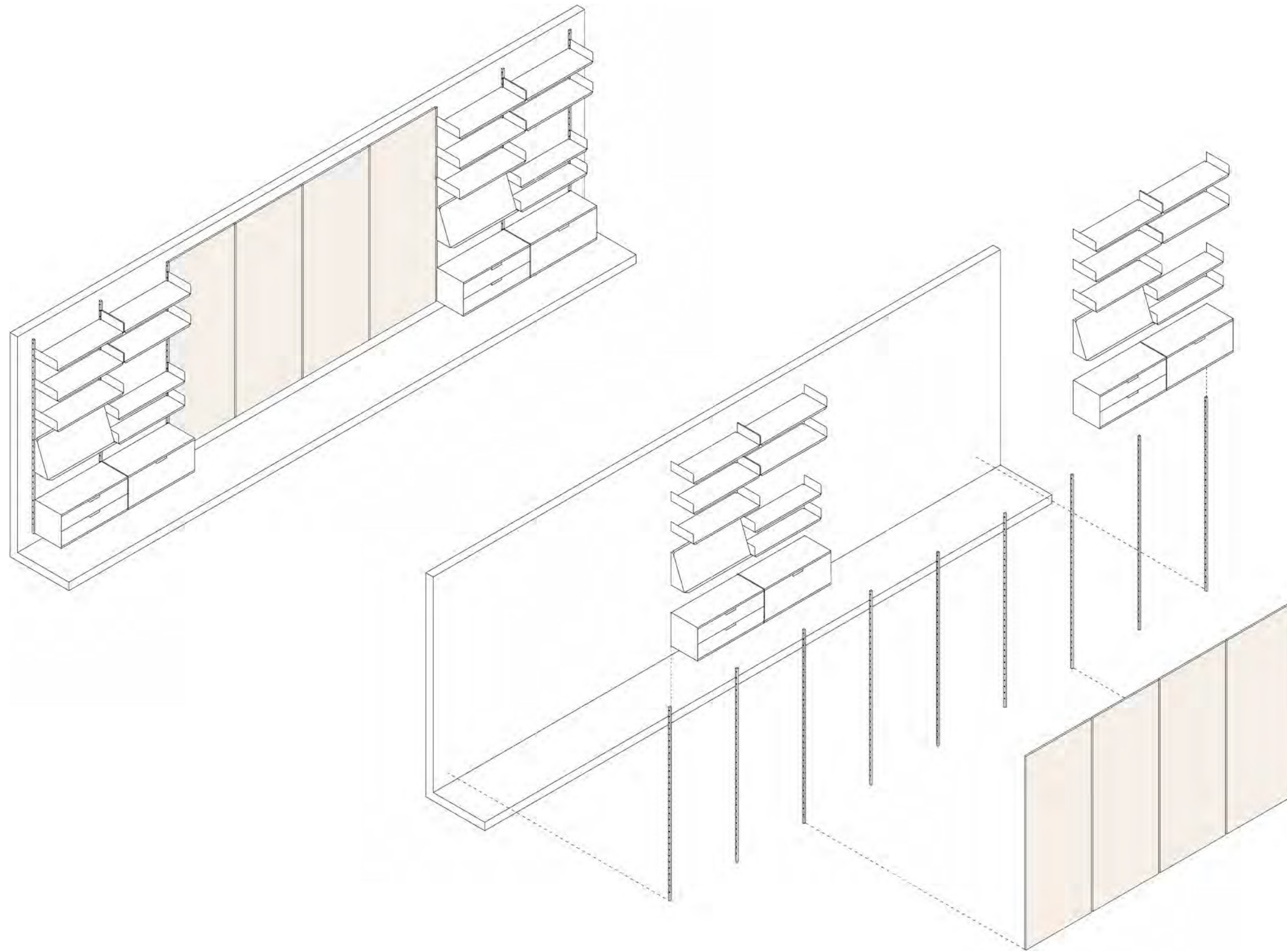

STAIR DETAIL

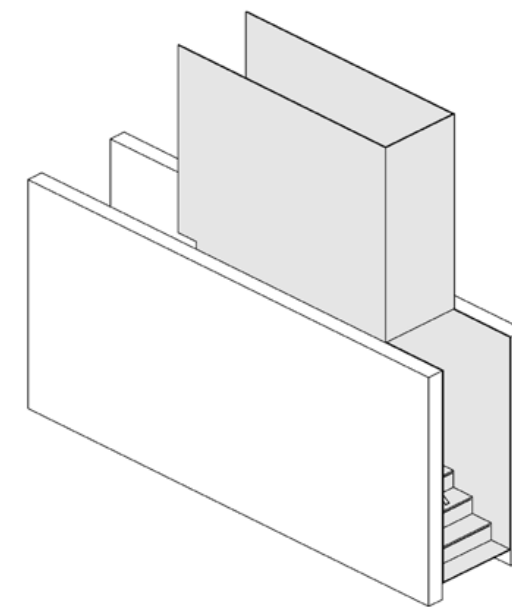
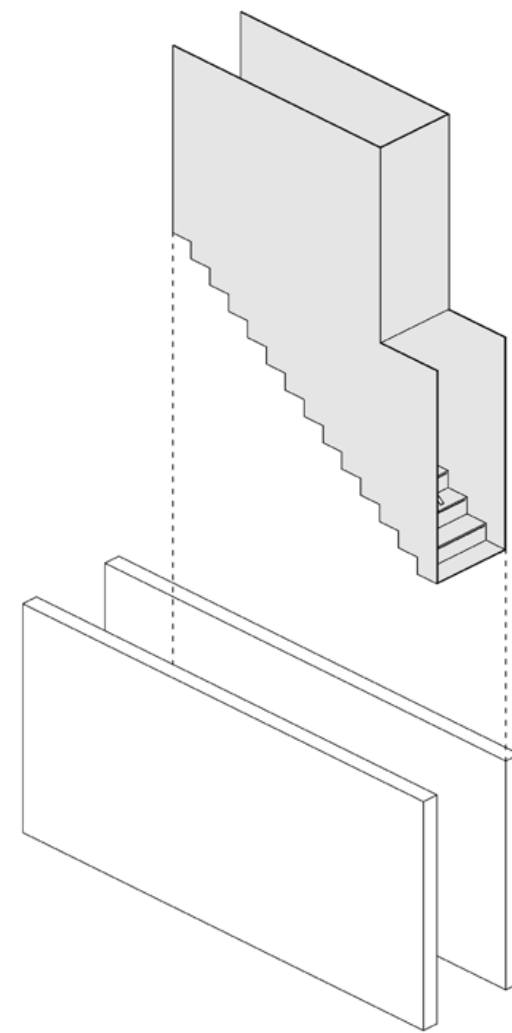
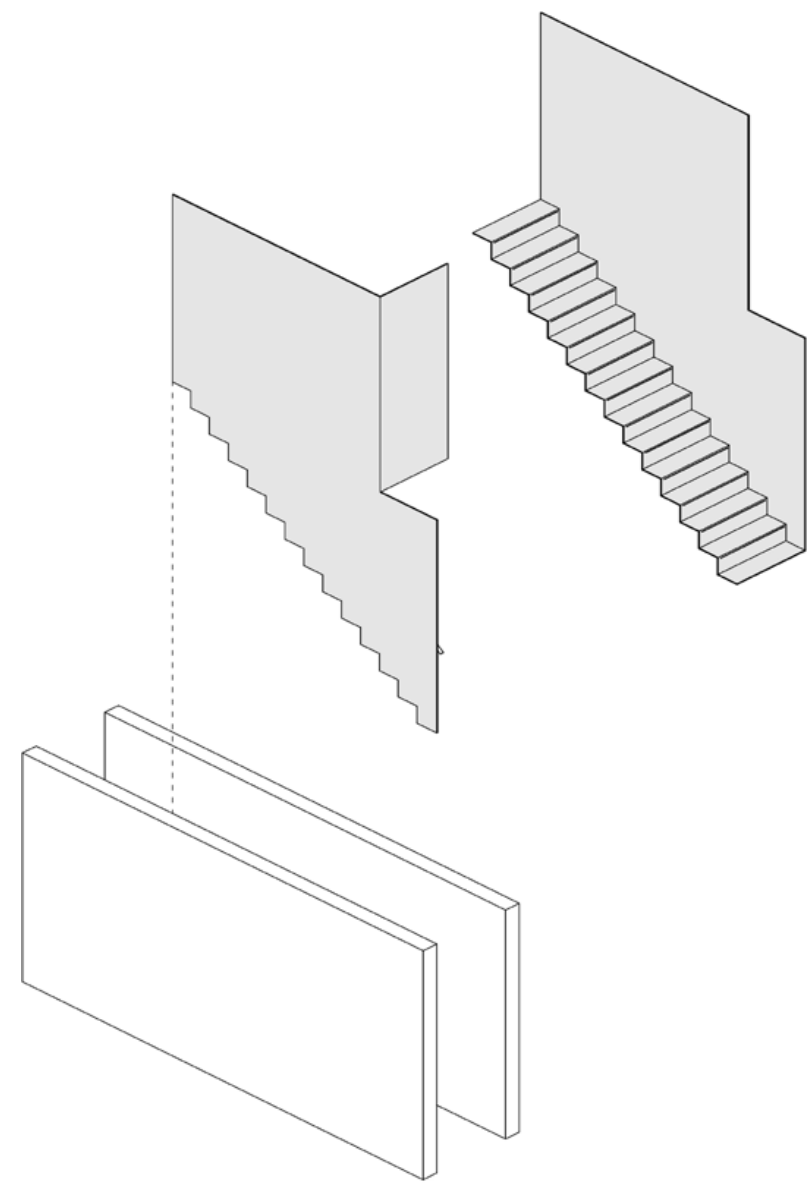

STORAGE SYSTEM

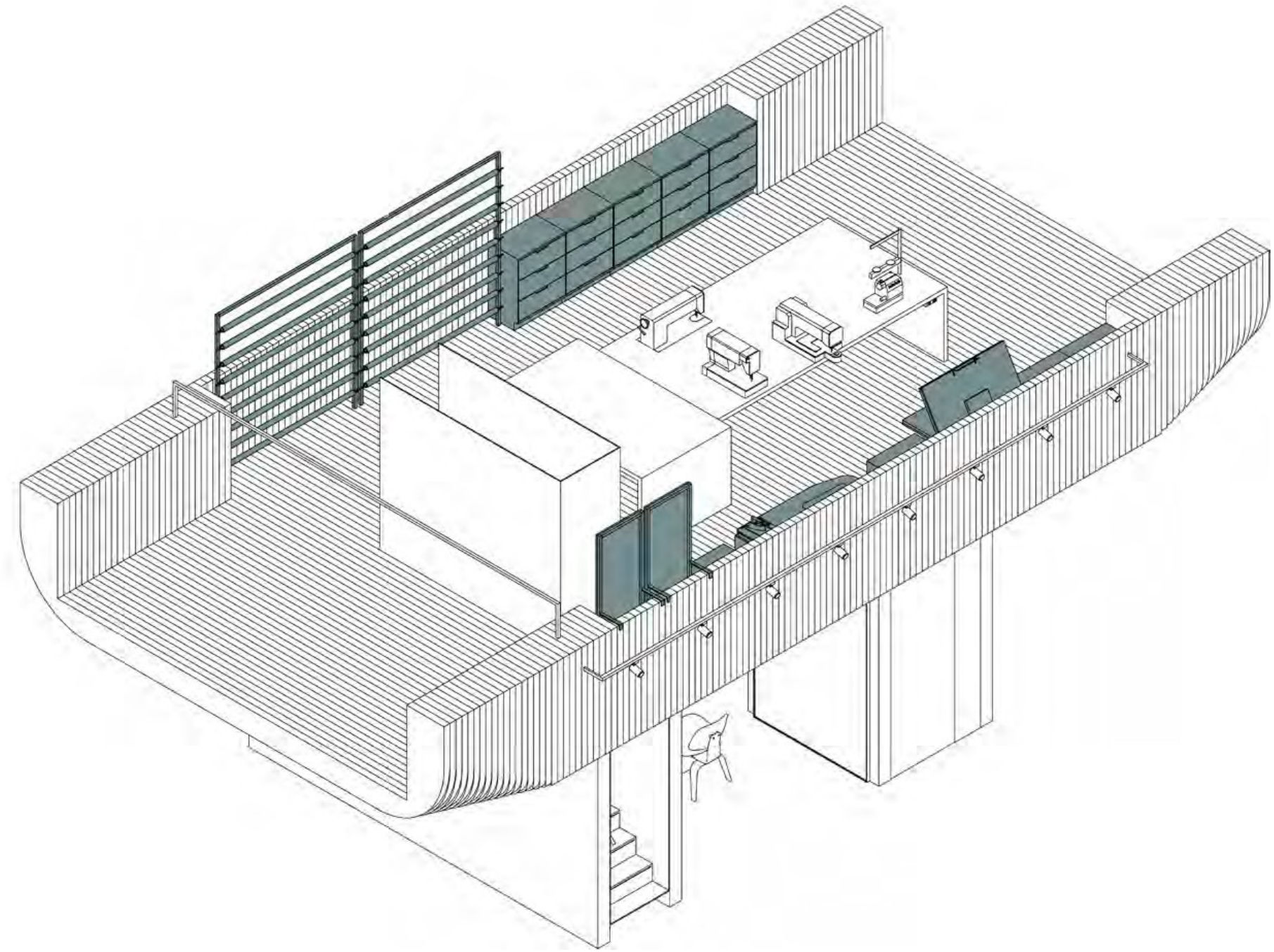
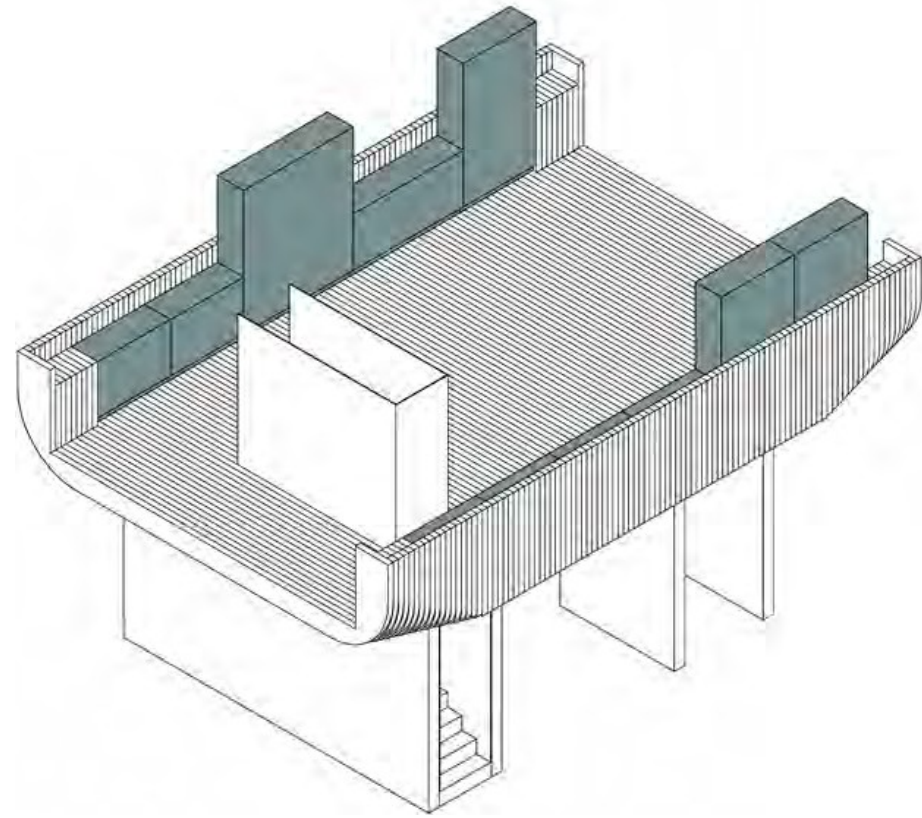
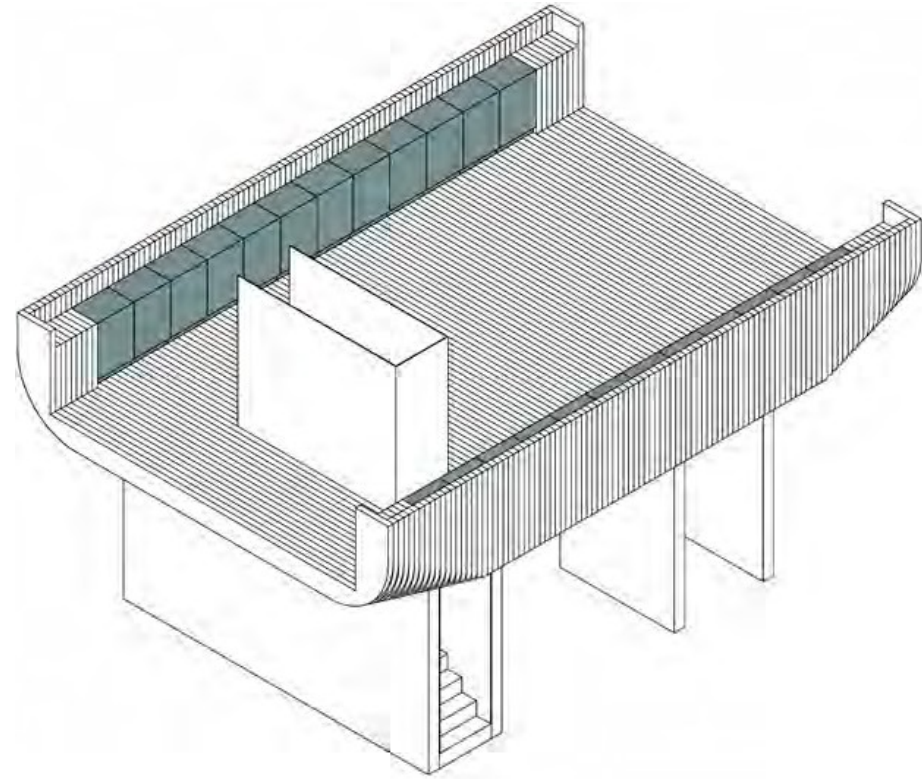

FABRIC STORAGE

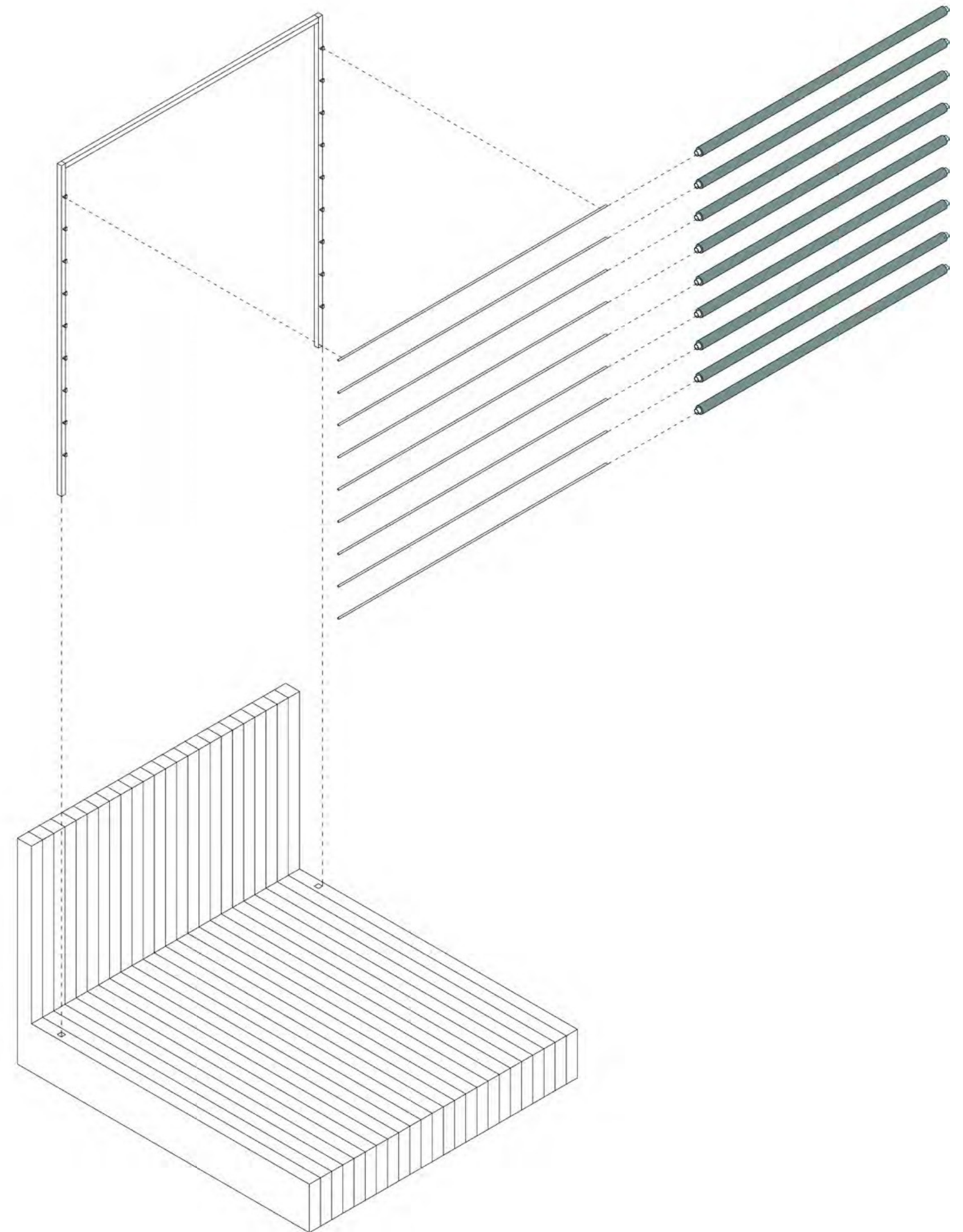
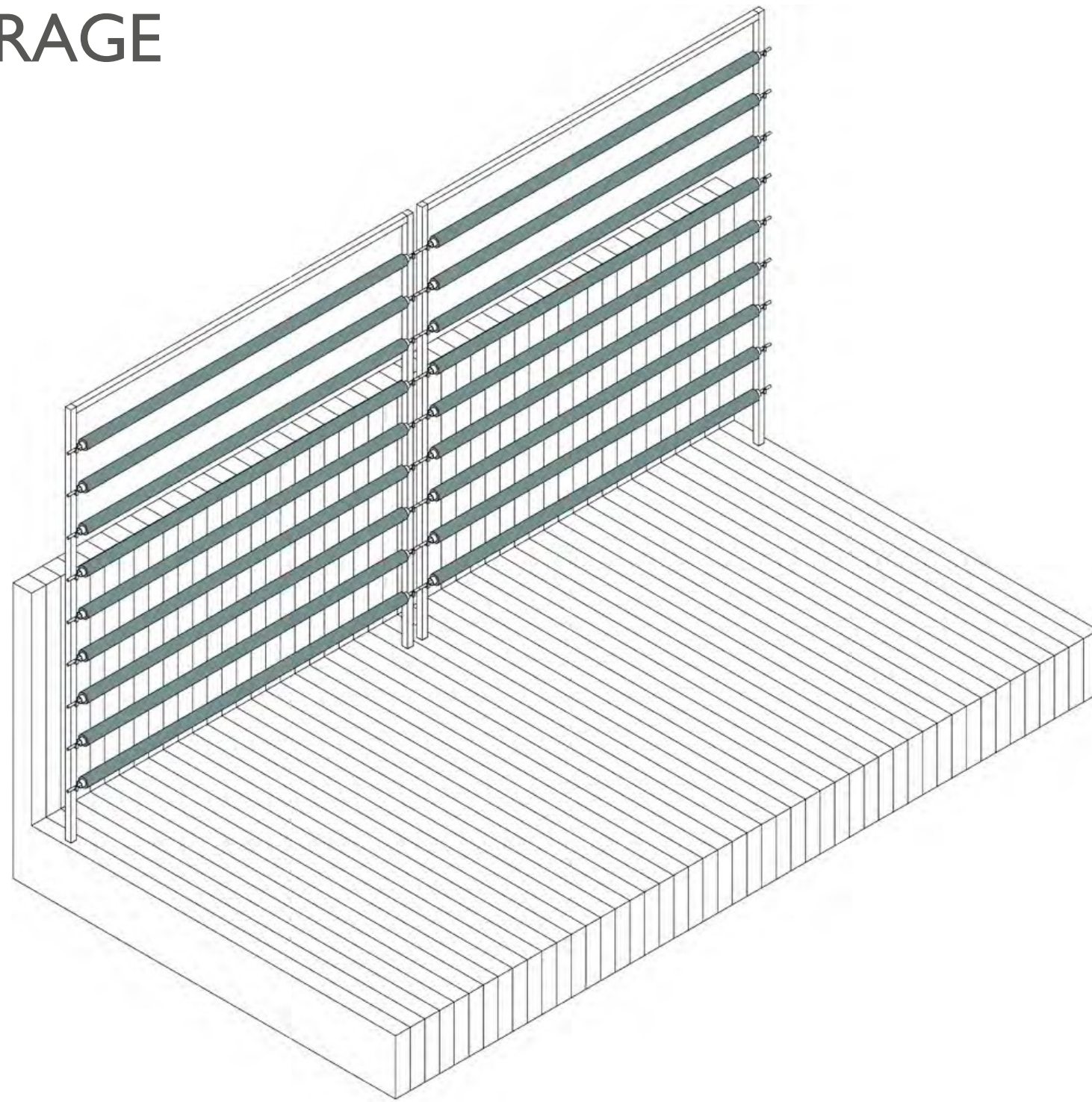

PEGBOARD STORAGE

